

# The Arup Journal







## Contents

- 4 Sky's Believe in Better Building**  
Rachel Atthis Mike Beaven  
Declan O'Carroll Timothy Snelson
- 14 Ipswich Chord**  
Martin Beeton Andrew Belcham  
Andrew Carr Jane Collins  
Barnaby Crawshaw Andrew Davies  
Gordon Richardson Matt Ringrose  
Graham Thomas Mark Wilmot
- 22 Hong Kong's Waste-to-Energy Plant**  
Carrie Chu Giuseppe Mollica  
David Pegg Simon Pickard  
David Pickles Kamal Siriwardhana  
James Sowden Susanne Sugiarto  
Chris Tidball Young Wong
- 42 The Dr Chau Chak Wing Building**  
George Cunha Jorg Kramer
- 52 Malampaya Depletion  
Compression Platform**  
Rene Ciolo Andrew Grime  
Leon Lorenti Brian Raine
- 64 Galecopper Bridge**  
Sander den Blanken  
Frank van Berge-Henegouwen  
Pat Moore Daan Tjepkema  
Dimitri Tuinstra

Front cover: The Dr Chau Chak Wing Building, University of Technology, Sydney.  
Photo: *Andrew Worssam*.

Left: Hong Kong's waste-to-energy sewage sludge treatment facility combines state-of-the art engineering with an ingenious architectural approach.  
Photo: *Sky Eye Co Ltd*.

# Sky's Believe in Better Building

## Location

Osterley, UK

## Authors

Rachel Atthis Mike Beaven Declan O'Carroll Timothy Snelson



1.

1. A 'social staircase' suspended along the entire side elevation links all four floors of the building with the plaza outside. A wall of windows floods the interior with light.

2. Timbered breakout areas, adjacent to the staircase, augment the social feeling within the building.

## Introduction

Sky is Europe's leading entertainment company, serving 21 million customers across five territories. When the company decided to redevelop its campus headquarters in London to mark its 25th anniversary in 2015, it turned to Arup Associates, strengthening a decade-long relationship.

The Believe in Better Building, which is amongst the first results of the redevelopment, is one of the most sustainable, innovative and unusual commercial buildings in the UK. It has an architecture created around the people who will experience it, and incorporates extensive environmental innovation, most notably its use of sustainable wood.

The UK's tallest open-plan timber building of its type, it is complex and beautiful, social and interactive. And the project is just as significant for the way in which it was designed and delivered, with the design team

co-located and responding quickly to client ideas, weaving architecture and engineering design with equal value.

In this way, it has become an exemplar project for Arup Associates' 'Unified Design' approach: it combines leading engineering thinking with strong architectural ambition in a building that creates, celebrates and expresses organisational and social interactions. A place for people.

With awards from World Architecture News and the UK-based Institution of Civil Engineers already to its credit, the Believe in Better Building has set a new benchmark for the delivery of commercial buildings.

## The project

The Believe in Better Building sits in a prominent position in the middle of Sky's London headquarters campus. It houses Sky's training and development suite, office space for more than 200 Sky employees, the Sky Academy Careers Lab, which provides

employment training for 16–19 year olds, and is a venue for community events and school visits. By 2020, Sky aims to reach one million young people in the UK and Ireland to build their practical skills and experience.

The brief, from Sky's CEO, Jeremy Durroch, was originally for a temporary venue. This evolved rapidly into a brief for a permanent building – but the programme remained essentially the same. With less than a year to go from the kick-off meeting to handing over the project to the client, the design team would have to work seamlessly and at a speed only made possible by close co-located integration.

Such a demanding programme drove solutions that enabled Mace, the contractor, to build the headquarters in a rapid, efficient and adaptable way. So, while the timber construction is a showcase for Sky's long-term sustainability goals, it also served a very practical function.

The success of the Believe in Better Building is the story of an eight-week design window, a four-week turnaround from concept to scheme design, and start on-site just three months after the project's inception. Close collaboration between the architecture and engineering teams, the client and the construction team was essential. The project could not have been completed to such a tight timescale without a high degree of trust and a shared commitment to achieving excellence, meeting a brief that demanded adaptability and delivery on shared environmental ambitions.

Already, the project's influence is being felt elsewhere on the campus. The Arup-engineered health and fitness building, for example, is using timber systems and off-site construction techniques. And further afield, the project is generating interest internationally for its speed of design and construction and particularly its pioneering use of timber. This article focuses, however, on the Believe in Better Building.



2.

### Overview

Sky needed to provide space for those working at its London headquarters while phased redevelopment of the campus took place. Arup was already working with Sky on logistics and planning for the tight campus site, and prior to the decision to construct the Believe in Better Building, the masterplan had allowed for open space in the area where the building now stands. This idea was developed to create the notion of the building as a stage, with the external area in front as its auditorium.

As the campus redevelopment continued, the plaza would act as a place where people could interact as they moved from one new building to another. The Believe in Better Building would become part of a family of buildings which would include the already-built Sky Studios – Arup Associates' first building on the site. Sky Studios is widely recognised as Europe's most sustainable broadcasting facility.

The relationship of the building to the rest of the campus was developed to be open and transparent, with a clear visual connection between the inside of the building and the external plaza. As many of those coming to the building would be first-time visitors, Arup Associates adopted its 'Design for People' approach, to create easily-understood intuitive spaces that were direct and engaging. People should feel comfortable and understand how to move around the building without needing a map to show the facilities they would need to use, such as the lifts.

A very simple unifying feature – a social staircase – would be suspended along the entire side elevation, bringing together each of the four storeys from the ground floor. Through this staircase, people arriving at the building for the first time would immediately be able to see the number of floors in the building and its height. They would also feel engaged with their surroundings, with the piazza as an outside backdrop.



3.



4.

3, 4. Two views of the adaptable and flexible teaching and training rooms, which can be expanded or divided with folding screens.

5. The social staircase's timber soffits are all exposed, revealing the beauty of the wood.

### Form enabling function

The simple modular design of the building enables Sky to use it in a number of different ways. The building has three primary functions:

First, Sky's community outreach activities are based there. This is where children learn about careers in the media so the design responds to the need for child safety and compliance with the rules governing supervision of children.

Second, there is a dedicated set of cellular teaching and training rooms where Sky will run most of its professional training programmes. These training spaces are designed to be adaptable and flexible, with folding screens and small spaces that expand to double, triple and/or quadruple spaces, all acoustically sealed.

Third, the building provides general office space for Sky, and breakout space to bring all the building's functions together.

Depending on the function, the design allows a broad range of spaces to be created. There is a large floating ceiling within the middle zone of the building, reflecting the client's desire for this area to be used as a major gathering space.

To meet the ambitious timetables – and create a lightweight structure capable of offering the required levels of openness and transparency – timber construction was selected, and an early procurement route was established to ensure the manufacturers and builders could construct the building quickly enough.

### A place for people

The design includes various bespoke partitions that slide and unfold to interconnect a shifting landscape of rooms and spaces. These partitions provide the extra acoustic separation needed to allow multimedia teaching in adjacent rooms. A transfer truss, hidden in the third-floor plant room wall, means there is an open-plan, column-free space to accommodate large events.

The open staircase rises through the triple-height atrium to the rooftop terrace and restaurant, and at first and second floor level the stair width is increased to incorporate breakout spaces. These spaces enhance the

circulation of people throughout the building, and enable visual communication both across the floors and out to the plaza. This helps to create a social and interactive feel both within the building and on the plaza.

The raised floor (450mm-deep zone) houses the IT and MEP systems needed for the building and its under-floor air supply. Acoustic separation between the floors is enhanced by a cavity between floor and slab. No additional acoustic treatment of the timber is needed. By concentrating the services in the floor void, the services exposed on the soffits below are kept to a minimum, so ceilings were not needed and the timber soffits were exposed, which gives the building's interior a unique appearance.

### Structure

Choosing engineered wood as the material for the design meant large parts of the building could be constructed off-site. With as many as possible of the wet trades eliminated, building programmes could be accelerated very quickly. By using a rigorous and regular structural frame – with a 6 x 8m column grid – any anomalies in the building could be kept to the edges. For example, the main staircase for the building is hung from the outside of the building's frame.

As the structural frame was designed around lorry-sized dimensions, off-site fabrication could be used, speeding build time considerably. Timber frames are much lighter weight than their pre-cast concrete equivalents and so could be easily brought to the site by truck.

The construction of the building envelope – using two-storey-high insulated timber cassettes – took just five weeks. The large timber elements were light enough to be lifted on site with much smaller cranes than would have been necessary to lift steel and concrete. The timber cassette facades also provide the excellent air-tightness and U-values essential to the fabric-first energy strategy Arup had specified.

In order to provide an open-plan floor plate, structural walls are limited to the stair cores, lifts and divisions between plant and public spaces. This is unusual for a multi-storey timber building, in which stability is usually provided by numerous load-bearing walls or stability cores with steel bracing or concrete walls.





6.



7.

6. The cantilevered entrance creates a sense of drama and additional accommodation is built above it.

7, 8. The initial sketches and concept design for the social staircase and wall of windows.

9. The floor plates were optimised without sacrificing the quality of the interior or the building's legibility.

In the Believe in Better Building, stability is provided by the diaphragm action of the cross laminated timber (CLT) floor planks transferring horizontal forces to the cores. Within the cores, the CLT walls work compositely with the glulam columns to form cantilevered 'I-beams' that transfer the stability forces to the ground. The resulting push-pull is transferred to the foundations by the columns, and shear forces resisted by the connection of the walls to the concrete ground floor slab.

CLT floor planks span between primary glulam beams, supported by glulam columns on a typical 6 x 8m grid. The planks are typically continuous over two bays (12m). Primary glulam beams spanning 8m are provided either side of the glulam columns, and double beams (16m long) are used to again provide continuity and also to simplify the connection between the primary beams and the columns.

The use of double-spanning planks and beams reduces deflections, improves the vibration response, improves the robustness of the structure and speeds up the erection process by reducing the number of lifts. As serviceability criteria are often the driver for the structural design of timber buildings, the use of double-spanning planks and beams provided significant economy compared with a conventional simply supported scheme.

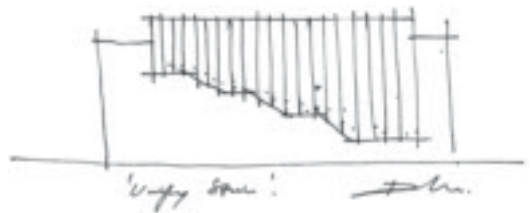
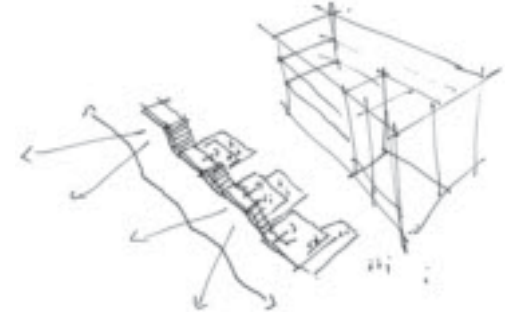

8.

As timber buildings are relatively lightweight, the use of piled foundations below the columns enables the net uplift from the stability forces to be accommodated without any significant effect on the foundations. The composite action of the glulam columns and the CLT walls also meant the glulam frame could be erected in advance of installing the CLT walls and planks, which improved the overall speed of construction.

The primary staircase cantilevers from the front façade of the building, creating a sense of drama. The primary staircase is also a 'social spine' with breakout spaces off landings and half-landings, and it maximises the regularity of the main floor plates on a constrained site.

The primary access to the site is along the western edge of the building. Additional accommodation is also created by cantilevering the building 5m over the western entrance, an architectural device that gives the building a much greater presence for approaching visitors.

All of this means that the floor plates have been optimised without sacrificing the quality of the interior, or the building's legibility.



## Substructure

The building is supported on continuous flight auger piles with a bearing slab. Plate tests were done on the site formation and also on the piling mat to justify ground-bearing of the slab, which reduced its thickness and allowed mesh reinforcement, speeding up its construction.

Detailed shrinkage analysis was carried out (using upper- and lower-bound estimates of pile stiffness to envelope the restraint provided) to avoid the use of the usual ground slab joints, which allowed larger, simpler pours and not joints. The substructure concrete uses 40% PFA cement replacement and 100% stent secondary aggregate to reduce the concrete CO<sub>2</sub>e by 37%, while also improving shrinkage.

The pile caps were designed as tapered thickenings in the slab, and poured integrally with it, to further reduce the overall build time. This provided a new challenge. Arup had to check the reinforcement on site for such a complex geometry, but the use of prefabricated cages sped up the process.

## Dynamics

Although timber systems are usually designed for a minimum natural frequency of 8Hz, some CLT structures can be more lively than that. Arup's designers carried out a rigorous dynamic analysis of the floor to show that the structure was stable enough, particularly around the cantilevers and atrium. The analysis accounted for the different stiffness of CLT planks in the cross-span and long-span directions, using varying walking speeds for corridors and longer walking paths, and allowing for the half-joint between planks to mobilise adjacent planks, but without full continuity.

The analysis showed that a fundamental mode above 10Hz was needed to achieve the required response factor of 8. The dynamic analysis was verified by on-site testing.

## Fire

The timber structure was designed to achieve a fire rating of 60 minutes through sacrificial charring, which avoids the need for applied protection (as would be needed for steel).

The need for sprinklers was also designed out, with a fire strategy of using both cores as protected and generous escape stair widths. This avoided a potentially expensive and time-consuming construction task. The slab soffits are also sprayed to inhibit the surface spread of flame.

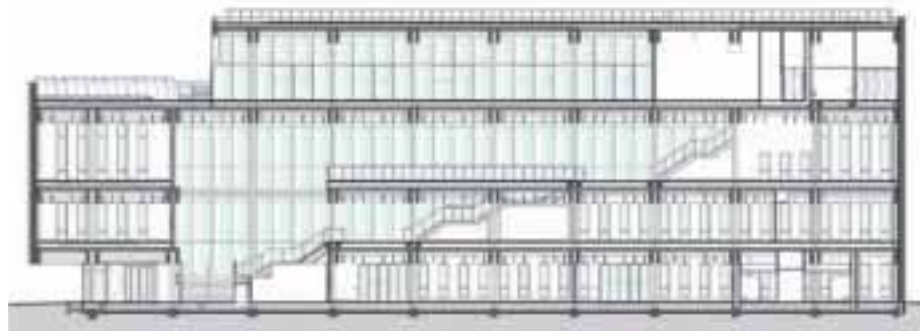
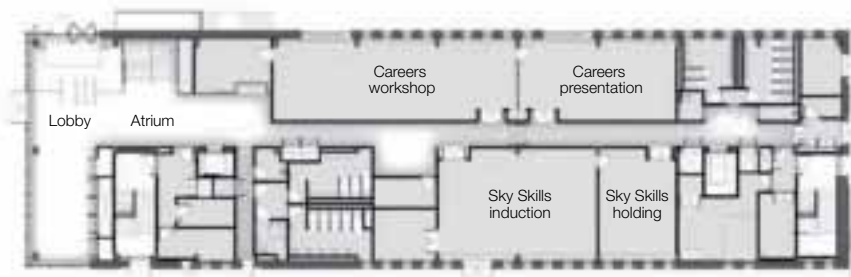
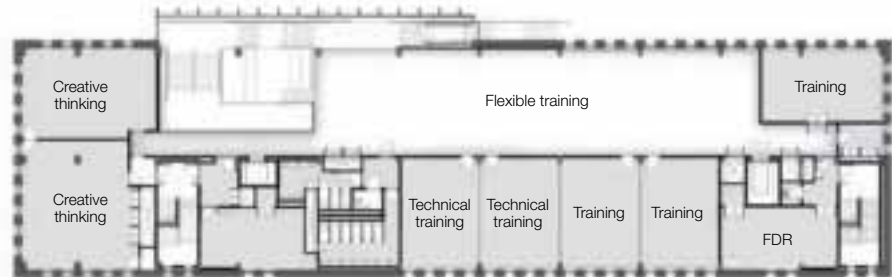
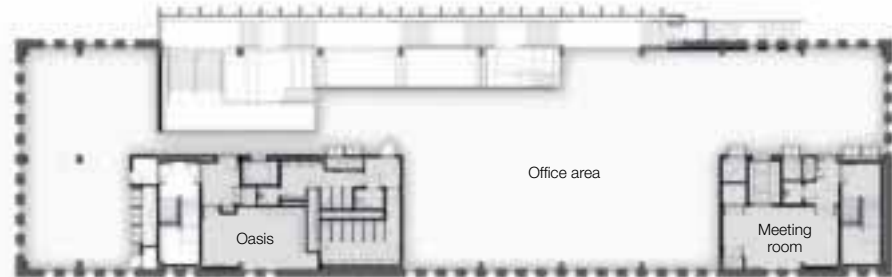
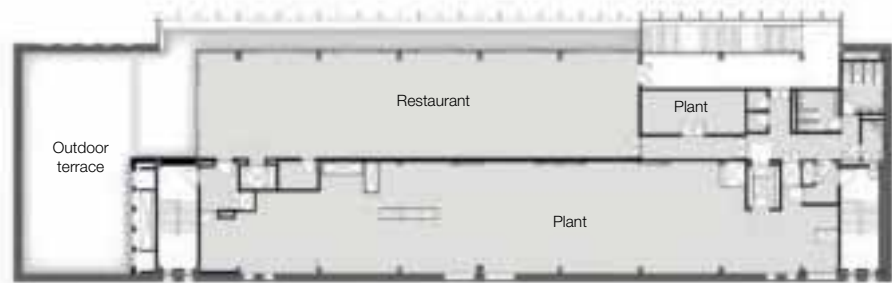

9.



10.

10. The north window visually connects the building with the plaza outside and allows daylight to flood along the main stair and into breakout spaces.

11. Lighting and ventilation strategy. 12, 13, 14. A combination of sustainability measures adds up to a BREEAM 'Excellent' rating, which will increase to 'Outstanding' when the building is connected to Sky's existing combined cooling, heating and power plant (CCHP).

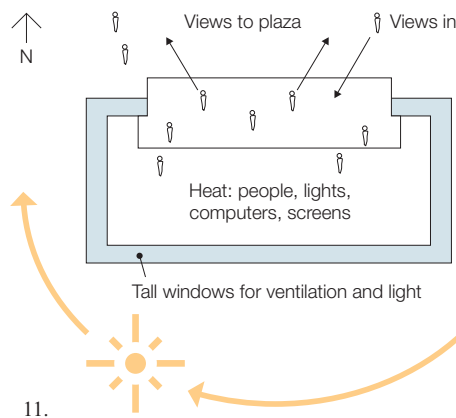

11.

### Environmental systems

Arup designed a fabric-first, mixed-mode energy strategy with high efficiency systems for the building.

Forming a strong aspect of the architectural expression, vision panels are configured, depending upon orientation, to minimise solar gain and maximise daylight: there are tall slot windows on the south, east and west, and a major glazed wall on the north. The north window visually connects the building with the plaza outside and allows daylight to flood along the main stair and breakout spaces. Solar gain has been further reduced by tilting windows away from the south (or towards the north), to reduce direct solar gain by up to 20%.

The fabric-first approach involves using two-storey timber cassettes with  $0.2\text{W/m}^2/\text{K}$  U-value to form 70% of the building envelope, reducing heat losses and optimising air-tightness. This results in an excellent heating demand for the building of only  $3.58\text{kWh/m}^2/\text{year}$ ; a 76% improvement on the Passivhaus standard of  $15\text{kWh/m}^2/\text{year}$ . Passivhaus is widely acknowledged as one of the leading standards for a fabric-first approach to low energy buildings.

The large panel cassettes, with taped joints, achieve an exceptional air permeability of  $3\text{m}^3/\text{hr/m}^2$  at 50Pa, which is 70% better than the UK's Part L building regulations require. This is equivalent to 0.15 air changes per hour, a 75% improvement on the Passivhaus standard of 0.6–1 air changes per hour at 50Pa.

The natural ventilation strategy is driven by roof-level vents above the full-height primary stair. Cross-flow through classrooms is via Arup-designed 'Sound Scoop' vents in walls.

The building uses a mix of natural ventilation and efficient mechanical systems with high co-efficient of performance (COP) air source heat pumps. Adiabatic cooling is used for summertime cooling on air handling units (AHU) and heat recovery on all mechanical ventilation, resulting in a heat demand of just 24% of the Passivhaus standard. Photovoltaic (PV) renewables, and the connection to the existing site-wide combined cooling, heat and power (CCHP) plant, will reduce the building's  $\text{CO}_2$  emissions by 40%.



12.

because it does not require the water it collects to be filtered. The Flowstow system conveys rainwater from the roof, by gravity, to cisterns located immediately behind WCs, discharging the water directly when required and avoiding the need for pumps and the associated electrical energy use.

This, together with low flow fittings, helped the building to achieve a 62.89% reduction in potable water over the BREEAM NC 2011 baseline.

**Material efficiency**

Embodied carbon calculations were done to compare timber structure against hybrid steel with CLT and also traditional concrete or steel approaches. Arup used its own in-house calculation software (PECC) to demonstrate that the whole building was significantly beyond zero embodied carbon, due to 1,200 tonnes of carbon sequestered in the structure. This is equivalent to 12 years of regulated operational carbon or 6 years of total operational carbon. The carbon impact of the timber is further reduced by the use of timber waste in CHP to heat and power the production factories.

The careful design means that the Believe in Better Building exceeds Sky's targets for operational and embodied carbon reduction, yet it was delivered within the costs of a traditional commercial office building.

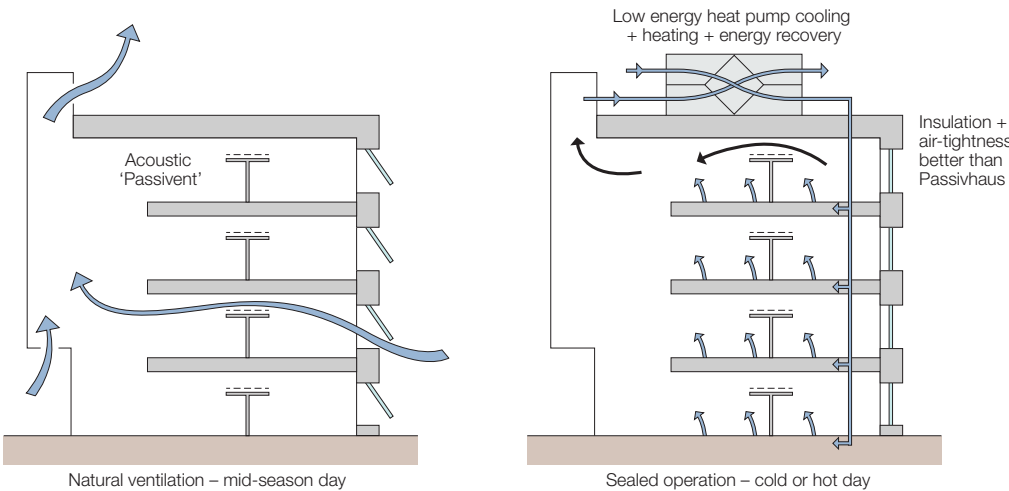

13.

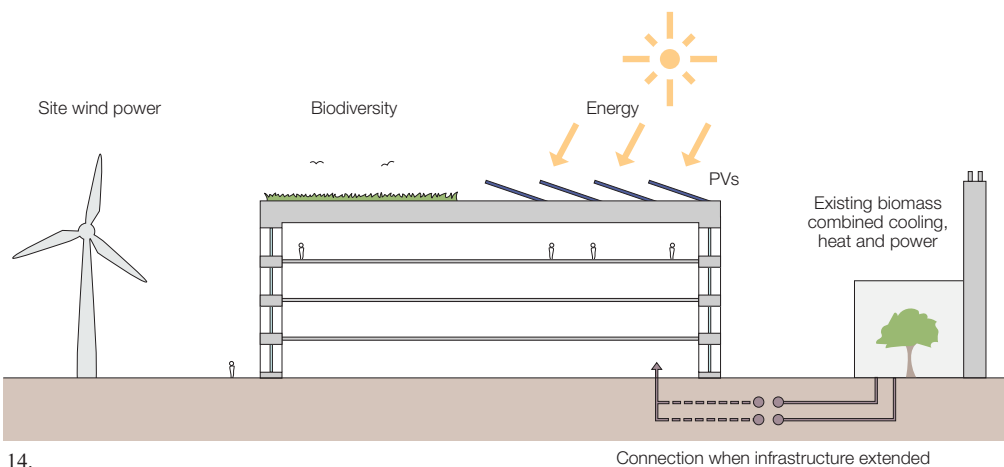

14.

The rejected heat from the water-cooled condensers associated with the computer room air conditioning (CRAC) units provides pre-heat to the hot water systems, halving the energy use of the heat pumps. Free-cooling also reduces energy demand on CRAC units.

**Water strategy**

Water efficiency was addressed by making use of a blue roof – a roof that collects water for re-use in a building – that feeds the innovative Flowstow rainwater harvesting system. This system, developed by Arup Associates, saves prime rooftop space

**Sustainability and wellbeing**

Sky is a 'carbon neutral' company, which means that it offsets unavoidable operational carbon emissions in high-quality offset projects. Campus-wide aspirations include BREEAM 'Excellent' environmental ratings for the buildings, and stringent key performance indicators for responsible sourcing, including the distance materials travel to site, biodiversity and the embodied carbon of the builds.

The Believe in Better Building was designed from the beginning with sustainability at its core. It has been awarded a BREEAM NC 2011 'Excellent' rating with a score of 78.4% in 2015, excluding CCHP. The project has been designed for connection to Sky's recycled wood/biomass CCHP through district heating and, when this happens, the BREEAM score will increase to 'Outstanding' level. The building currently achieves an EPC energy rating of 'B', which will increase to 'A' when it is connected to the CCHP.

Alongside sustainability, the design team considered the health and wellbeing of those who would use the building. Designing for ‘wellness’ was a key criterion, which meant incorporating optimum levels of day-lighting, ensuring good air quality and making extensive use of natural materials.

Research suggests that timber buildings inherently contribute substantially to improving the wellbeing of building users, compared with more traditional concrete construction techniques. The design team enhanced this advantage with measures such as internal and external tree and shrub planting throughout the building and on the plaza, and using materials with ‘low’ or ‘no’ volatile organic compound (VOC) content.

In terms of community engagement, the project has already trained more than 100 local people – both trainees and apprentices – and funding has been made available to those who work on site for at least four months to take further qualifications if they choose.

Over 10 months, the project team (Arup Associates, Mace and Sky) has completed 441 hours of local volunteering, including maintenance work on the neighbouring River Brent for the Canal and River Trust and fundraising for the Teenage Cancer Trust.

**BIM**

BIM was essential to the smooth running of the project. It was used extensively, enabling everyone involved to understand the building as a prototype and providing data for use by Sky’s estate managers.

The design team, contractor and client were able to work through problems, solve them before going on site, and undertake genuine collaborative design. Arup originated the BIM model as a common federated model, and the supply chain fed into it.

Sky employed a BIM manager who brought together the model of design and construction parties to facilitate 3D reviews and design stations, which were critical to the success of the project. Mace used the models for 4D programming to plan logistics strategies on this very tight site and this was critical to meeting the timetable.

BIM was also used to schedule element quantities for input to carbon assessments, check cost models throughout the project



15.

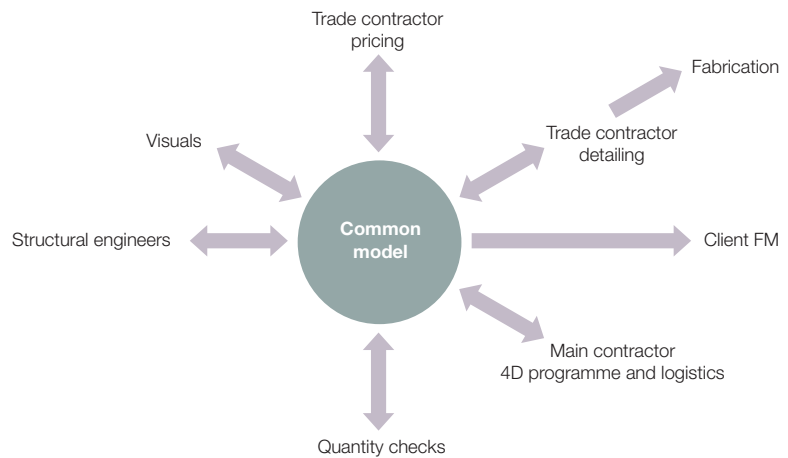

16.

and get early supply chain cost and programme feedback into the design. This enabled the frame manufacturer, B+K Structures, to reduce their tender time from three weeks to two.

BIM was essential for coordinating the design to enable early release of substructure packages for construction. B+K adopted the Arup structural model and enriched it for

fabrication, including major builders’ work openings coordinated off-site prior to fabrication, avoiding the usual retrofit of builders’ work openings on-site. Their final model was brought back into the design building model to ensure ongoing coordination with architecture and services. The result was almost no site-made openings through the timber.



17.

### Conclusion

Only with this integrated team of architect, engineer, contractor and client could the Believe in Better Building have been built in such a short time, to such high quality.

The project exemplifies Arup Associates' 'Unified Design' approach of bringing together diverse elements of engineering and architecture into a high quality design that adapts itself to its users' requirements and is delivered at speed. Multidisciplinary innovation is possible when designers are co-located with architecture, structural, mechanical, electrical and public health teams.

The Believe in Better Building itself is an inspiring place for creativity and learning, a flagship for Sky, and an inviting multi-functional space for occupants and visitors. It is also a sustainable design that makes intelligent use of day-lighting and natural materials.

It was important that the building was completed in time for Sky's 25th anniversary celebration – and the success of the project meant that it was delivered ahead of schedule, with a month to spare.

### Authors

*Rachel Atthis*, Lead Architect and Project Manager  
*Mike Beaven*, Lead Services and Sustainability Engineer  
*Declan O'Carroll*, Project Director  
*Timothy Snelson*, Lead Structural Engineer

### Project credits

Client: *BSkyB* Architect: *Arup Associates* Main Contractor and Project Manager: *Mace* Landscape Architect: *Capita* QS: *AECOM* Structural and Services Engineer: *Arup Associates* Acoustics, Facade, Fire and Civil Engineering: *Arup – Paul Adams, Ann Marie Aguilar, Steve Allen, Mel Allwood, Rachel Atthis, Michael Beaven, Maja Belic, Martyn Biss, Alice Blair, Alexis Brown, Karim Budabuss, Adrian Campbell, Hans Chao, James Cheung, Alexandra Clement-Jones, Carl Collins, Dan Dale, Mike Edwards, Kate Fletcher, Clint Frost, Carolyn Gallehawke, Franziska Gautschi, Ellie Griffiths, Sarah Hooton, So Hyun, Stephen Kearney, Michael Kinney, Ian Knowles, Joost Lauppe, Vicki*

*Lockhart, Chris Macdonald, Melissa Mak, Sophie McClements, Fiona McGarvey, Declan O'Carroll, David Parsons, Nitan Patel, David Pearce, Catherine Rankine, Scott Reid, Paul Robinson, Charles-Elie Romeyer, Elmar Rottkamp, Costanza Santovetti, Rob Saunders, Adam Smith, Tim Snelson, Ryan Taylor, Julie-Anne Walker, Jeff Widd.*

### Image credits

1, 2, 3, 4, 6, 10, 15, 17 *Simon Kennedy*;  
 5, 7, 8, 11, 12, 13, 14, 16 *Arup Associates.*

15. The wellbeing of those who visit the building, or work there, is enhanced by the use of materials with 'low' or 'no' VOC content.

16. BIM was essential to the smooth running of the project.

17. Inspiring and sustainable, the Believe in Better Building is a flagship at the heart of Sky's Osterley campus.

# Ipswich Chord

## Location

Ipswich, South East England

## Authors

Martin Beeton Andrew Belcham Andrew Carr Jane Collins Barnaby Crawshaw  
Andrew Davies Gordon Richardson Matt Ringrose Graham Thomas Mark Wilmot



1.

1. Aerial view of the Chord.

2. Plan showing the bridges and junctions.

## Introduction

The Ipswich Chord is set to play a critical role in the UK's Strategic Freight Network Upgrade project. This is the story of how a comparatively short section of railway – cleverly planned, designed and value engineered by Arup – is dramatically improving freight capacity and how it has already started to bring significant environmental and commercial benefits to the East of England.

The Port of Felixstowe is Britain's biggest and busiest container port, pivotal to the success of the UK economy. One of the largest ports in Europe, it hosts around 30 shipping lines carrying goods to and from 400 ports around the world. Efficient road and rail links connecting the port to the

rest of the UK are critical to its success and future growth.

The Chord is a brand new double-track section of railway, 1.2km long, with double junctions at each end connecting into existing rail lines. Prior to the opening of the Chord in March 2014, there was capacity for 28 freight trains per day in and out of Felixstowe. The implementation of the Chord will enable future growth in freight capacity – there is now the potential for the number of trains per day to increase substantially, if required, after other infrastructure improvements are complete. This enhanced rail network promises to take 750,000 heavy goods vehicle movements per year off the heavily congested trunk road network, and it has been designed to meet European interoperability standards,

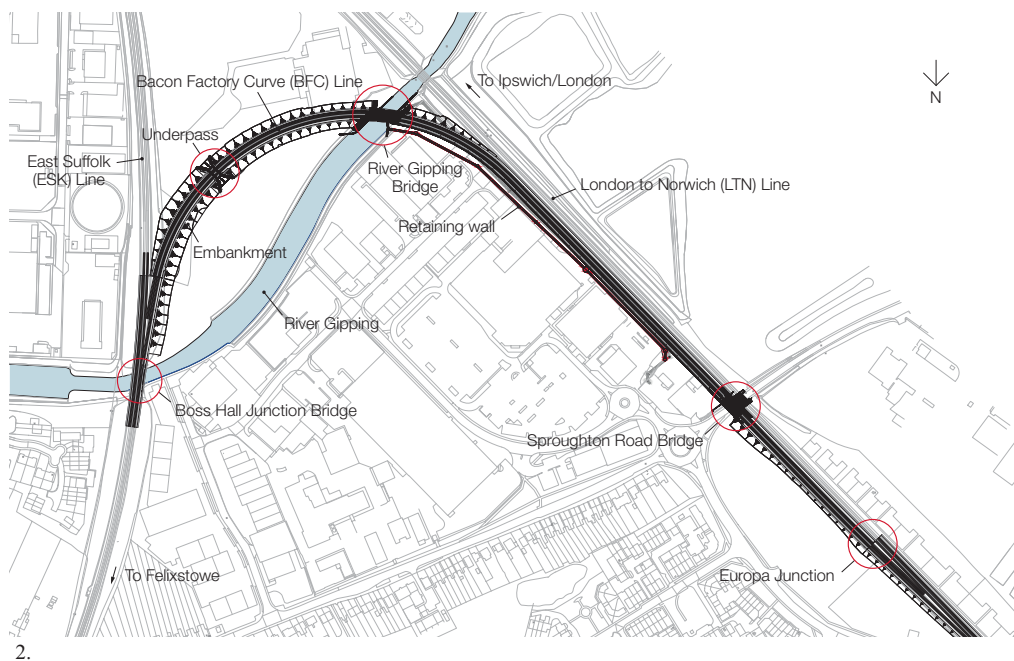

From a technical perspective, however, there was concern that frequent heavy freight trains traversing a tight radius curve would generate excessive friction, resulting in frequent and costly track renewals.

Arup worked with Manchester Metropolitan University to show that a tight radius curve was feasible. Advice was provided on the whole-life cost of the scheme, including future maintenance, track renewal considerations and operational issues arising from stopping and starting a large number of trains potentially stalled on the Chord.

#### The Development Consent Order

Network Rail went on to develop the scheme through the preliminary design process, defining it in sufficient detail to submit a Development Consent Order (DCO) to the UK government in 2011. It was the first ever rail DCO. Under the DCO process, related consents such as planning permission, compulsory purchase of land and property, and protection of water resources are combined into a single application.

For the Ipswich Chord, the DCO set out rigorous requirements for environmental protection and management, including ecological conservation, protection of water resources, noise, archaeology, and waste minimisation. Compliance with these requirements had to be agreed with the local authority – Ipswich Borough Council – before any work could commence on site.

#### The brief

In 2012, Network Rail commissioned The Spencer Group for the detailed design and build of the Ipswich Chord, and to implement associated improvements to Ipswich Yard. The £70 million scheme was renamed the Ipswich Rail Enhancement Project, and commissioned as part of the wider-reaching UK Strategic Freight Network Upgrade. The Spencer Group subsequently appointed Arup to develop detailed multidisciplinary design on a design-and-build basis.

which means that all trains and containers arriving from Europe can use the Chord for onward travel.

#### Historical context

In the late 19th century, when Felixstowe was a popular seaside resort and small port, the Felixstowe to Ipswich rail line was built to carry passenger trains and freight. During the 20th century the port grew, shifting the balance towards freight, and by the 21st century it was clear that additional rail links to the rest of the UK were needed, particularly to the Midlands, which is a hub for imports and exports.

Between 1999 and 2008, the number of containers passing through Felixstowe more than doubled, accompanied by a similar growth in train movements. Yet the only routes to the Midlands and on to major northern cities such as Manchester and Liverpool were either indirect via Norwich and London, or involved reversing in freight sidings next to Ipswich station to use the more direct line to Nuneaton via Peterborough (the Ipswich Yard ‘run round’).

The Felixstowe to Nuneaton Capacity Upgrade project to enable transport of more freight, more quickly, between the East Coast and the Midlands via Peterborough was first mooted in the early 2000s.

#### The Bacon Factory Curve

In 2008, Network Rail, which owns and manages the UK’s rail infrastructure, commissioned Arup to investigate the viability of the ‘Bacon Factory Curve’. This curve – so named because it cuts across derelict land previously occupied by the Harris Bacon Factory – could connect the existing Felixstowe and Norwich lines just north of Ipswich station.

The new curve (now named the Ipswich Chord) could provide direct paths for freight trains from Felixstowe towards Peterborough. This would also reduce congestion on the London to Norwich main line, enabling the future increase of passenger services between London and Norwich to the benefit of businesses in the East of England.



3.



4.

3. Boss Hall Junction bridge in place after the Christmas blockade.
4. Ipswich Chord location.
5. Ground conditions around the River Gipping.
- 6-8. Boss Hall Junction Bridge construction sequence:
  6. Possession prep – existing bridge and new bridge substructure.
  7. Concrete deck – existing bridge and new deck (constructed off-site) ready for slide.
  8. Finishes – New Boss Hall Junction Bridge.

The Arup brief encompassed all civil and structural engineering work, including four new bridges, environmental management systems and rail engineering. This element included permanent way (track), overhead line electrification (OLE), lineside electrical, signalling and telecoms systems. Arup also provided site technical liaison with the contractor during the construction period.

In addition, the Arup team negotiated agreements relating to ecology, landscape design, archaeology, waste and resources, traffic management, noise and vibration, air quality and light pollution, working with The Spencer Group to develop pollution incident controls and a communications plan that, in combination, ensured prompt access to the site and timely practical commencement of work.

### Project constraints

The significance of the project to the UK Strategic Freight Network Upgrade brought pressure to complete it quickly. Initially an 18-month design and build contract, the schedule was further tightened by issues with third party land access, which meant the actual construction period was limited to 11 months. The normal duration of similar projects would be around 24 months, bringing a collaborative working arrangement and innovation to the heart of our design delivery.

Land access was a big challenge. The site was hemmed in by rail, river and urban development, so the team needed to acquire consent and support from local landowners and property users. In addition, the DCO placed stringent conditions in the form of environmental restrictions relating to multiple river crossings and nearby housing. There were also interfaces with major utilities, necessitating the diversion of a large sewer along the length of the retaining wall and medium-pressure gas main diversions in the vicinity of one of the bridges.

Working alongside a live railway meant that an intricate plan of staged construction, testing and commissioning was essential to maintain safe operational performance. A track possession regime was prescribed at the outset for the design and staging of the works.

### Environmental Management Plan

Arup developed clear criteria for the Design Environmental Management Plan (DEMP), including a continuous focus on resource efficiency that saved 7,500 tonnes of aggregate and concrete through design modifications and led to the recycling of 790 tonnes of materials. Features including a riverside nature reserve to protect species such as otters were built into the scheme.

The DEMP was translated into a comprehensive Construction Environmental Management Plan (CEMP), which ensured contractor compliance with the DCO and eliminated the potential for delay arising from public complaints or regulatory enforcement.



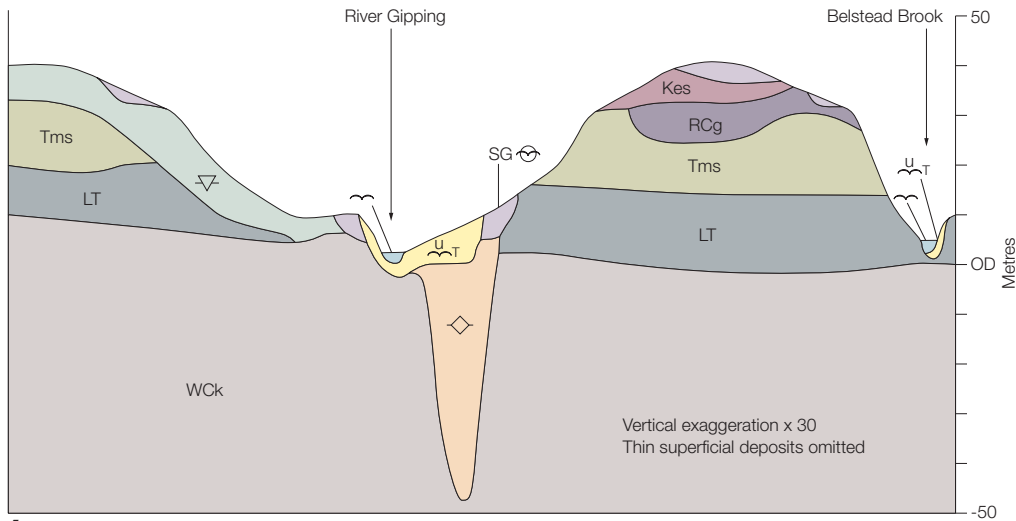

5.

As the first DCO project of its kind, the Ipswich Chord has set a precedent for this type of rail development in the UK. Agreement on sensitive issues was achieved through open negotiation with the relevant authorities to establish a high level of trust and mutual confidence.

**Ground conditions**

The Chord is built almost entirely on embankment, reaching a maximum height of 5m. Ground conditions generally comprise river terrace sands and gravels overlying chalk bedrock, but complications arise from the presence of a buried channel within the chalk and the presence of an in-filled channel and alluvial deposits associated with an earlier alignment of the River Gipping.

Initially, Arup developed Network Rail’s original ‘Form A’ design. However, three months into the project, additional ground investigations revealed that soil conditions were much worse than expected. This led to a redesign, which was further complicated by land ownership and access issues. The team took possession of the site later than expected, which provided only eight months for construction and settlement of the embankment for the Chord, compared with an initial assumption of 18 months.

**Geotechnical design**

For the first time on the UK rail network, ‘Controlled Modulus Columns’ (CMCs) were installed by subcontractor Vibro Menard and used as ground treatment beneath the new embankment in areas of significant alluvial deposits. This technology had been proven elsewhere, but because this

application was the first of its type in the UK, it was subject to a Category III (independent) check and extensive review by Network Rail.

The interface between new and existing earthworks posed a challenge to the design of the new switch and crossings (track junctions) onto the existing lines. The existing embankments at the junction intersections had been in situ for over 150 years and were therefore fully settled into place. This necessitated development of a transition track bed design between the new embankment (which would settle over time) and the old, with a view to minimising future track deflection issues and the associated maintenance costs of re-aligning the track in the event of ground settlement.

Subsequent settlement monitoring of the new earthworks confirms that the performance requirements set for the project have been achieved.

Deep piled foundations to the underlying chalk were used for all the bridge structures, with works phased to limit rail possession requirements. The design of the Chord earthworks included an innovative pile transfer mat to minimise settlement between embankments and bridge abutments.

**Bridge and civil structural design**

All bridges and other civil structures were designed and modelled from the outset in 3D using Solidworks™ parametric CAD software. This allowed detailed clash detection and construction sequencing strategies to be fully worked out, identifying

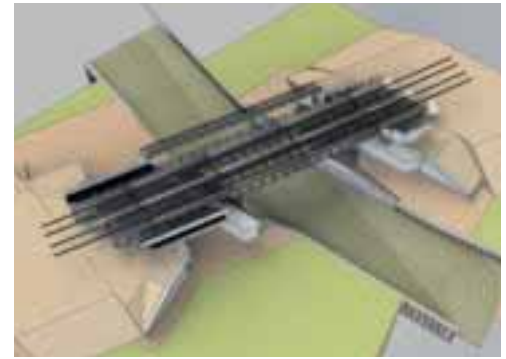

6.

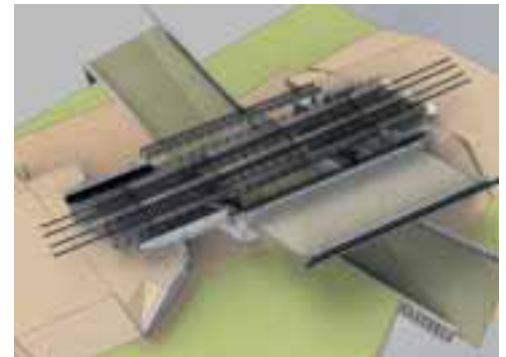

7.

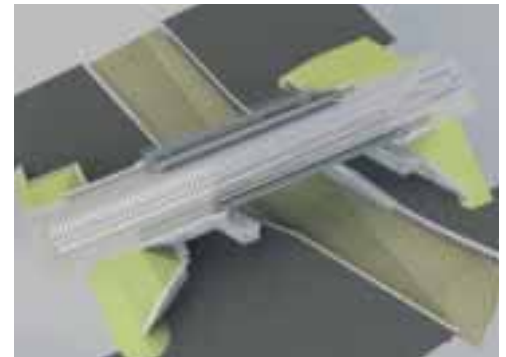

8.

issues before they arose and thereby reducing construction risk. This was particularly valuable when developing the construction sequence for Boss Hall Junction Bridge, minimising the number of diversions and interfaces with existing utilities.

**Boss Hall Junction Bridge**

The existing bridge had to be replaced with a widened structure to accommodate the new junction and track geometry. At the start of the detailed design process, it was found that the original ‘Form A’ design did not account for a number of the key design constraints, including the additional deflection criteria required to accommodate switches and crossings on the bridge. This resulted in a complete redesign of the structure.



9.

The original design assumed that the bridge would be lifted, complete, by crane. At detailed design stage this was discounted because the bridge was too heavy for available cranes and there was an associated risk of disruption, due to weather, during a critical track possession.

Arup's design provided a deliverable, constructable method of lower-risk installation, with the bridge fully constructed offline and slid transversely into its final position during a blockade.

### **Sproughton Road Bridge**

This new bridge is adjacent to an existing bridge carrying the main London to Norwich (LTN) rail lines. The steel superstructure was built in a compound 500m from the site and installed by self-propelled modular transporter.

The piles and abutments for this structure had to be built around existing infrastructure. A layout had been developed assuming that an existing water main under the eastern abutment would be diverted as part of enabling works. However, during construction Arup was asked to develop a piling layout that accommodated the water

main, with the added challenges of avoiding existing structures and minimising the number of piles that needed to be installed in possessions.

Using a 3D model of the piles and the water main, a revised pile layout was developed that highlighted potential constraints to the piling contractor and reduced the risk of striking the main.

### **River Gipping West Bridge**

This bridge has the largest span (28.2m) and skew (40°) of the four new underbridges along the Chord. The main technical consideration on the structure was developing a way to prevent additional load from the bridge and embankments loading the existing sheet piled river training walls.

This was achieved by designing the front row of piles in the abutment as a contiguous pile wall to retain any residual spill through loading from the adjacent embankment, which itself was supported on a transition arrangement of CMCs.

### **The Christmas blockade**

The issues connected with the installation of Boss Hall Junction Bridge and associated



10.

track works demanded an extraordinary team effort before and during the 2013 Christmas holiday.

In rain, snow and sleet – in fact, some of the worst winter weather on record in the UK – the team demolished and removed the existing steel bridge using a 1,000 tonne mobile crane. Then the new superstructure was slid into place. The construction sequence involved building the replacement span alongside the existing bridge before the blockade, then using the five days of the blockade to lift out the old structure and slide in the new.

9. Sproughton Road Bridge being transported to the site.
10. Reptiles had to be protected as part of our CEMP.
11. Ipswich Chord track layout with check rail visible alongside inner radius of curve.



11.

While the Chord embankment earthworks tie-in was completed, new track, switches and crossings and ballast were installed. It was an intense period of work, the backbone of the scheme, and it moved the project forward substantially.

### Railway systems design

The Chord is a 1.2km plain line twin track curve with a significant portion on an extremely tight radius curve, meaning that along its length there are no junctions, crossovers or points.

At the start of the 'Form B' process it was found that 'Form A' had not accounted for certain requirements of the technical specification. So the alignment around the curve was redesigned to increase the standard track centrelines (the distance between the twin tracks) to allow future provision for Eurostar trains (Class 373/2) to pass each other.

Despite the track centres being widened, the overall width of the embankment was reduced from the original proposals in a value engineering exercise, resulting in a

smaller footprint, less engineering work, smaller volumes of imported fill and significant cost savings.

Standard railway track installation in the UK normally takes the form of continuous welded rail (CWR), where rails are stressed in situ to achieve a stress-free condition when the rail temperature reaches 27°C. Above this temperature the rails start to expand and the resultant compressive forces have to be controlled.

As the Chord required the track to be designed on a very tight radius, the conventional approach of using CWR would have resulted in excessive lateral expansion and a build-up of compressive forces within the rails. Potentially, this could not be managed by conventional means, leading to the risk of buckling in very hot weather. Instead, standard fish-plated joints were used, which meant the Chord essentially comprised a number of track panels bolted together with room to expand in a linear direction. Arup used detailed calculation techniques to work out the length of each rail around the curve to allow the panels to be

pre-constructed in their curved form prior to installation, thereby reducing the amount of on-site work normally required.

Arup was also tasked to review the 'whole life cost' of the new Chord (the future cost of maintaining and/or repairing the asset). Although not required by current standards, Arup proposed and introduced a 'check rail' – an additional rail, installed parallel to the running rail. This restrains wheel movement and prevents aggressive wear characteristics on the opposite running rail which, left unchecked, would lead to increased renewal frequency on such a tight curve. The check rail also has the beneficial effect of stiffening the trackform and preventing localised alignment defects (the gradual movement of the track from its intended position).

### Europa Junction

This end of the Chord allows trains to connect with the Great Eastern Main Line at speeds of up to 50mph. The layout comprises a double junction with a switch diamond; the geometry constraints make this the first of its type to be installed within the UK rail network.

A huge consideration in the design of this junction were the implications of installation, with track access being a major factor. The junction needed to be installed over several weekends, in a series of short track possessions, to allow uninterrupted passenger service. This was achieved by designing a bespoke modular system of bearers and rail – essentially a kit of parts – to be installed quickly and efficiently in stages.

The flat geometry designed where the Chord lines diverge from the main line effectively reduced the amount of land take and drainage alterations which would otherwise have been required for a standard geometrical layout.

### **Boss Hall Junction**

The position of Boss Hall Junction on top of the reconstructed bridge meant that close liaison with the bridge designers was essential to meet standard deflection criteria for switch and crossings while designing a layout which could be installed within allocated possessions. A bespoke modular arrangement was designed, taking account of where bridge abutments, deck and transition slab interface.

The Chord at this junction intersects the LTN on the opposite hand curvature to the existing, creating a contra flexure double junction. The technical role here was to redesign the Form A cant (deviation from flat) arrangement and place the whole junction flat and level, thus improving its maintainability and whole life cost.

### **Overhead Line Electrification**

As the adjacent Main Line is already electrified with OLE, the Chord required a short distance of overhead line run-off protection in the form of a 'dummy overlap'. This was carefully sectioned and designed so the Chord can be fully electrified in the future without affecting safe operation of the Main Line. This 1.2km new section of OLE involved removing 16 existing overhead structures, reusing seven structures and designing an additional 19 overhead structures. The Yard was re-sectioned to assist in a more deliverable maintenance regime, requiring an additional 40 OLE structures. Arup's approach to standardising pile lengths for ease of construction on the Yard enabled an early start to construction. The foundation design was similarly considered as part of the embankment design. Foundation installation was required ahead of the embankment works, and therefore tubular steel pile foundations were chosen in preference to traditional concrete 'side bearing' foundations to avoid intrusive retrospective installation.

### **Signalling and telecoms**

From a signalling perspective the overall solution was complex. The Chord and Ipswich Yard upgrade, although separate projects, were intrinsically linked.

To facilitate approvals, Arup proposed that both schemes were joined to provide a clear understanding of the complete picture, then devolved into discrete projects for independent delivery. The knowledge gained by combining the schemes revealed that an alternative signalling interlocking solution to that previously proposed was required.



12.



13.

Initially, both schemes were independently planned to accommodate required enhancements within the ageing GEC geographical interlocking based in the relay room adjacent to Ipswich station. However, Arup found that space constraints, disruptive track access and confined cable entry to the relay room via the platform made this approach undeliverable.

Instead, the team devised a way to implement the Chord using a new route relay interlocking to control all the new signalling

required for the Chord and associated new junctions at Europa and Boss Hall.

The solution, which was built and tested extensively offline, maintained the existing remote control from Colchester Signalling Control Centre by introducing an additional field-end Delphin/PIIU system. This avoided a much more disruptive track possession and saved a space-intensive additional telecoms link in Colchester.

The Yard design maintained the philosophy of amending the existing GEC geographical interlocking. The interlocking controls East Suffolk Junction and encompasses both the East Suffolk (ESK) lines toward Lowestoft and the LTN mainlines. The main constraint with the access requirements meant that disruptive possessions of both the LTN and ESK lines were minimal.

Arup devised a way of 'splitting' the interlocking by creating an additional common control set (interlocking area) with the addition of a special split-ring set from a later version of the GEC system, which was unique to the Ipswich area. Once implemented, this meant the Yard could be substantially isolated from main lines, allowing enhancement works to commence independently.

12. Europa Junction switch and crossing installation.
13. Geographical signalling set.
14. First train across the Chord on 31 March 2014.

### Ipswich Yard

The Ipswich Yard remodelling scheme, which followed completion of the Chord project, involved extending and remodelling an existing siding facility to accommodate longer freight trains.

Arup's continued role involved extending three sidings to provide a minimum of 662m of train 'standage', converting an existing through goods line into a reception siding, providing a new line connection towards Felixstowe, associated electrification, drainage, bridge parapet upgrades, associated S&C, signalling, civil engineering, electrification and plant and telecoms.

The preliminary design was optimised through a detailed design process to provide a best value solution and the newly-upgraded Ipswich Yard, completed in 2015, is now fully operational.

### Conclusion

The Ipswich Rail Enhancement Project brings immediate and enduring benefits to the Port of Felixstowe, the UK freight network and the local economy in the East of England. The first train ran on the Chord on 31 March 2014.

National rail freight services have been enhanced and network resilience improved with more trains running between Felixstowe and the Midlands each week, which removes lorries from the road network; passenger services have been improved; and the project has provided employment and training opportunities in the East of England that may attract future young professionals to join the railway industry.

Environmentally, when the project benefits are fully realised by 2030, it is estimated that the reduction in train journey times to Peterborough, and the reduction of road vehicle movements, will result in a net saving of 210 tonnes of CO<sub>2</sub> per year.

Ipswich Chord won 'Best Large Project' at the Network Rail Partnership Awards 2014.



14.

### Authors

*Andrew Belcham* is a Director and UK Rail Operations Director, and was Project Director on the Ipswich Rail Enhancement Project.

*Martin Beeton* is the UK Signalling Technical Head and an Associate Director in the Midlands Campus office; he led Signalling input to the project.

*Andrew Carr* is an Associate in the Manchester office and led Rail Systems design input to the project.

*Barnaby Crawshaw* is Senior Marketing Coordinator for the Arup Global and UKMEA Rail Businesses.

*Jane Collins*, an Associate Director in the Manchester office, led Geotechnical input to the project.

*Andrew Davies* is the UK Permanent Way Technical Head and led Permanent Way input to the project.

*Gordon Richardson*, an Associate Director in the Manchester office, led Environmental input to the project.

*Matt Ringrose*, an Engineer in the Leeds office, was the Arup site representative during the construction phase of the project.

*Graham Thomas* is an Associate Director in the Leeds office. He was Project Manager and also led Bridges input to the project.

*Mark Wilmot* is the Arup UK E&P Technical Head and led Overhead Line and Electrification and Plant input to the project.

### Project credits

Project Owner: *Network Rail*; Client: *C Spencer Limited*; Civil and structural engineering work, environmental management systems and rail engineering: *Arup – Dom Ainger, Irfan Akram, Steve Allen, Francesco Anselmo, Laura Ashley, Sylvester Atiba-Davies, Ese Avwokuruaye, Jonathan Aylwin, Sam Baldwin, Giovanni Bank, Joe Barry, Martin Beeton, Andy Belcham, Michael Bennett, Simon Bradbury, Alex*

*Briggs, Olly Carlton, Andrew Carr, Michael Chai, Tariq Chaudhry, Dave Clark, Liam Cole, Jane Collins, John Collins, Angela Cook, Tom Curran, Andrew Davies, Richard Deakin, Simon Dicken, Richard Fletcher, Rob Gillespie, Alastair Gordon, David Gregory, Lisa Gregory, Mark Griffiths, David Guite, James Haigh, John Haygarth, Adrian Hayton, Emma Haywood, Jo Hollingworth, Kevin Hourihan, Justin Howell, Bob Hudson, Lukasz Jakielaszek, Suzanna Joy, Irfan Khan, Andy Kirwan, Jake Knight, Ian Lanchbury, Mike Lomas, Yichun Lu, Sergio Macias Torano, Amanda Magee, Richard Marsh, William Martin, Kate McDougall, Rory McEwan, Scott McGee, Peter McKeever, Richard Mellor, Colin Mills, Adam Morgan, Sam Moss, Sean Muhsin, Khurram Nazir, Catriona Neath, Sonam Norbu, James Oakley, Ansuya Oogur, Annie Pace-Burr, James Park, Daniel Patten, Adam Pickles, Mario Querol, Aaron Ratchford, Gordon Richardson, Phil Richardson, Matt Ringrose, Richard Scrivener, Alex Shah, Nick Sidhu, Adam Smout, Ray Stafford, Mark Steele, David Stewart, Luke Styler, Darren Styles, Mohanaragm Sundharam, Patrick Swainson, Tim Taylor, Katarzyna Tekieli, Graham Thomas, Sue Thomson, Stephen Till, Dan Timmins, Deepak Verma, Ian Walker, Ben Walmsley, Dave Ward, Rob Warner, Mel West, Chris Williams, Darren Willis, Mark Wilmot, Nigel Wooldridge.*

### Image credits

1–2, 4–14 *Arup*; 3 *Matt Ringrose*.

# Hong Kong's Waste-to-Energy Plant

## Location

Hong Kong, China

## Authors

Carrie Chu Giuseppe Mollica David Pegg Simon Pickard David Pickles  
Kamal Siriwardhana James Sowden Susanne Sugiarto Chris Tidball Young Wong



1.

## Introduction

In Hong Kong, Arup's design team has developed a self-sufficient and sustainable solution to dispose of up to 2,000 tonnes of sewage sludge per day in the largest facility of its type in the world. The heat generated is recovered for power generation, and power surplus to the plant's requirements is exported to the regional electricity grid. At full operational capacity, an excess of 2MW of power is available daily.

The Hong Kong Government's Environmental Protection Department, which owns the plant, wanted its new Sludge Treatment Facility (STF) housed in an architecturally distinctive building that would be functional yet visually attractive. Veolia won the design-build-operate (DBO) contract and Arup worked with the Veolia-Leighton-John Holland JV on the engineering-procurement-construction (EPC) contract to devise and deliver an iconic structure.

Inspired by Chinese mythology, the building's flowing roofline is fashioned in the shape of a dragon's wings and the rising waves of the sea. Yet the design is intensely practical. Its shape is ideally suited to the linear production line within, and it was constructed in modular form, which helped the JV meet the tight construction timescale of just 37 months. The building was completed in late 2014 and operation commenced in early 2015.

## The project

The STF was conceived in response to increased investment in sewage infrastructure and the forecast increases in sludge that this new infrastructure will yield as a result of higher levels of treatment to domestic wastewater and diversion of effluent from preliminary treatment works in the urban area. The effluent will pass through a network of deep sewer conveyance tunnels to a centralised sewage treatment works at

Stonecutters Island. The overarching scheme (also an Arup project) is called Harbour Area Treatment Scheme Stage 2A (HATS2A).

The STF will incinerate the sludge produced at HATS2A and other sewage treatment works (up to 2,000 tonnes of wet sludge per day), and the foul wet sludge that would otherwise be dumped in landfill will be reduced to ash and residues, a reduction of about 90% by mass.

Before STF, all dewatered sewage sludge went to landfill, which is not sustainable. The STF implements the fluidised bed incineration technology that is part of the Government's more effective sludge disposal strategy.

This article focuses on the planning, engineering and technical services Arup provided to enable commissioning and initial trial operation of the plant.

### Arup scope

Arup was engaged during the tender stage in 2009 for geotechnical, civil and structural design. The brief was later extended to include mechanical, electrical and thermal engineering services. The Arup design team, led by David Pickles, conceived the facility layout and preliminary engineering concepts and worked with Vasconi Architects on the innovative architectural concept.

Detailed design commenced in October 2010, under the leadership of David Pegg (Project Director), David Pickles (Technical Director) and Richard Hatton (Project Manager). A dedicated design team of approximately 70 staff was established in a co-located project office with the EPC contractor (Veolia-Leighton-John Holland JV) and the architects. By the end of the project, more than 320 Arup staff had contributed expertise from offices in Leeds, Sheffield, Solihull Campus, Manchester, London, Sydney, Manila and Hong Kong.

The Arup scope of service included detailed engineering design for all civil, structural, geotechnical and building services associated with the buildings, as well as mechanical and electrical engineering for the facility: site-wide electrical power distribution system, HV grid connection, site-wide interconnecting pipework and mechanical support systems, performance specification for balance of plant and specialist services for fire engineering.

### Evolution of the design concept

The challenge of the 37-month construction programme meant developing a design that was modular in construction. Yet because the building had to be architecturally distinctive, it would be fundamentally different from other similar industrial treatment facilities.

The client's reference design envisaged a large main process building housing a single tipping bunker feeding six parallel incineration lines. This yielded a large rectilinear structure that would have to be constructed in a prescribed sequence, with



2.



3.

1. This exterior picture, taken from a drone over the bay, shows how the facility sits elegantly with its surroundings.

2. This map shows the location of the Sludge Treatment Facility (red dot) in relation to the 11 sewage treatment works that will feed it.

3. The floor plan of the two mirror-image main process buildings, housing identical processes.



4. Landscaping makes the building more attractive, more sustainable and more amenable to wildlife.
5. The plant fits exactly into the undulations of the roof.
6. Waste-to-Energy: the process.
7. Internal view of turbine building pipework.

roof profile, developed to emulate the wave symbolism, also yielded north lights for ventilation and natural day-lighting.

The ancillary buildings for power generation – comprising two turbines and condensers, desalination and water treatment facilities – were aligned symmetrically behind the main process buildings and interlinked by a high level viewing gallery, accessed from a central environmental education centre. The viewing gallery doubled as a pipe and cable bridge between the process buildings.

Sections of the site were zoned ‘environmentally sensitive’ for migratory birds, such as the Little Grebe, to use for breeding. The masterplan required reinstatement of the natural habitat for these birds after the project was completed, and the eastern portion of the site was reserved for this purpose.

#### Advanced thermal treatment technology and process flow diagram

The facility operates fluidised bed incineration technology on four lines, each capable of handling a normal load of 500 tonnes per day. This means there is spare capacity and the plant can operate on three lines in the event of scheduled maintenance, emergency repair or variance in sludge load.

The sludge is delivered to reception bunkers and then mixed, using the overhead grab, into more uniform feedstock and fed into the incinerator via sludge injection pumps. As the sludge is injected, contact between the sludge and the hot fluidised sand bed enables the initial combustion of the sludge, followed by a secondary combustion of organic components.

A selective non-catalytic reduction (SNCR) method is used in the combustion process whereby ammonia is injected into the boiler at the point where the flue gas is at an elevated temperature of 800°C to reduce the emission of nitrogen oxides.

4.

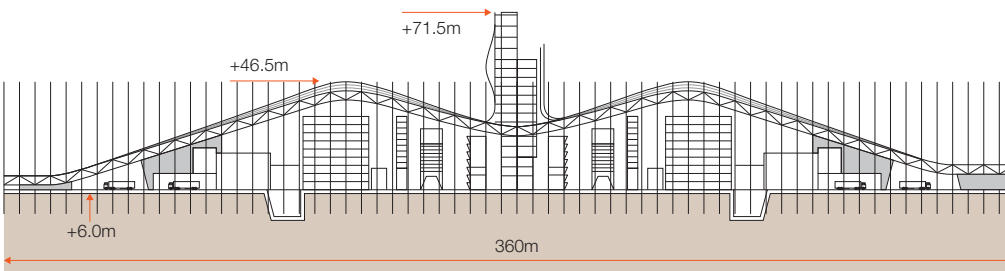

5.

limited flexibility for contingency in case of delays to either construction or equipment procurement.

In addition, the approved environmental permit imposed constraints such as the location of emission points for the flue gas treatment system and extraction points for seawater and brine discharge from the desalination plant.

For these reasons, the design team split the main process building into two mirror-image structures that could be created and built sequentially. This meant that learnings from construction, testing and commissioning the first half of the plant, could be embedded in the other half, reducing the amount of bespoke construction required before installation could begin. It also meant the contractor could provide at least half the required capacity (enough to meet initial operational demand) even if there were delays.

Having derived the modular concept, the team worked on developing the optimal process configuration within a structure that was efficient, and a building envelope that was architecturally distinctive.

#### Architecture

The architectural concept explored the possibility of creating long single-span roofs to resemble a dragon’s wings and waves gaining in height as they reached the seaward side of the building. This concept embraced Chinese mythology in which mountain-living dragons must be able to return to the sea.

It comprised a symmetrical configuration with the two main process buildings either side of a central administration tower that was used to hide the flue stack. The linear arrangement maintained the logical process flow that linked chute to stack, while the progressive changes in the heights of the process equipment provided the template for the dragon-wing roof structure. The sectional



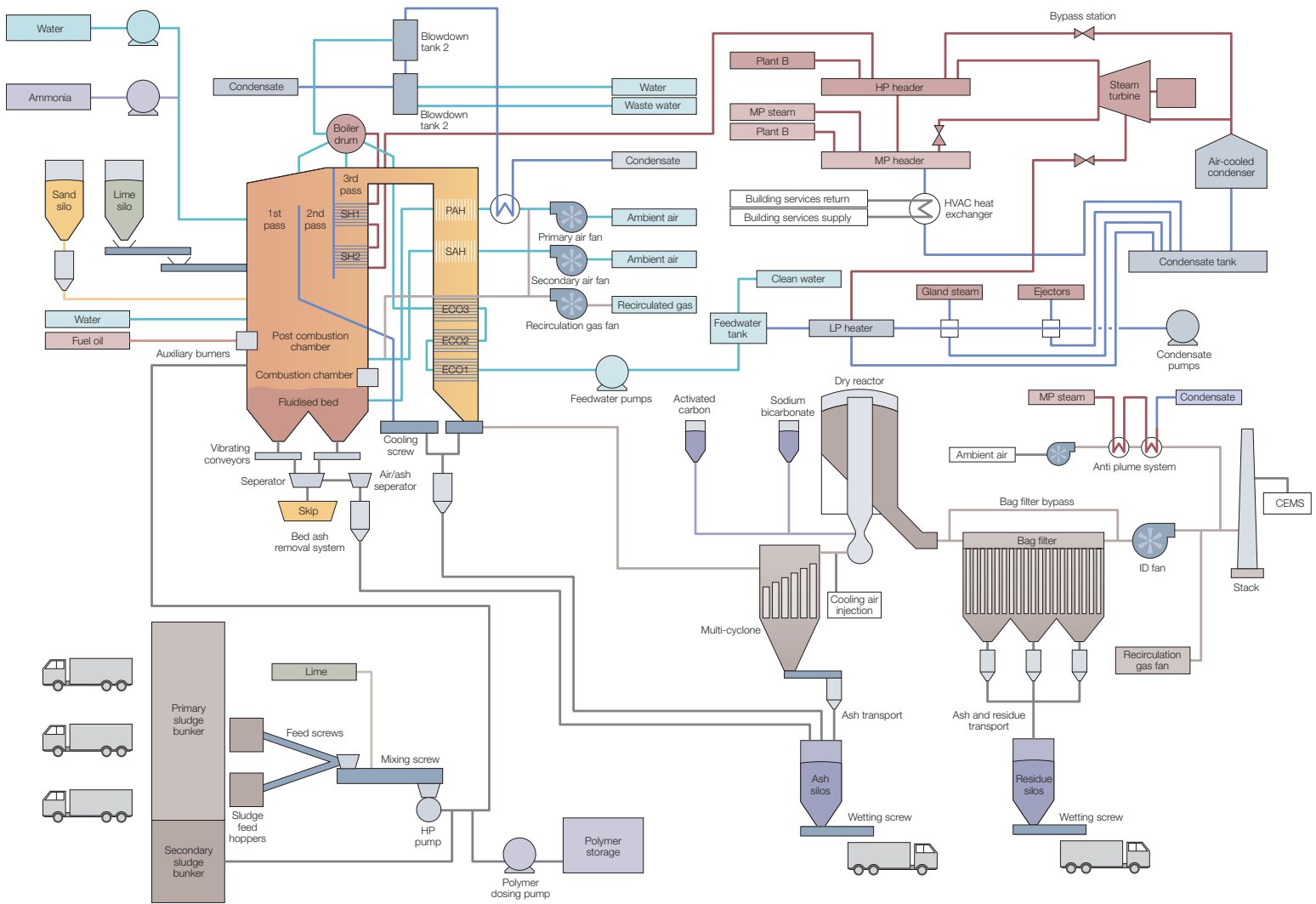

6.



7.

The flue gas exits the boiler and is further treated to remove nitrogen oxides, heavy metals and dioxins by injection of sodium bicarbonate and activated carbon in a dry reactor, with smaller particles removed by a multi-cyclone precipitator and bag filter. At the end of the incineration process, the bottom ash and residue amounts to approximately 10% of the original sludge mass.

Energy is recovered from the combustion processes via the transfer of heat to the boiler tubes to generate steam to drive two steam turbines. One turbine is capable of providing the required total power generation of 14MW (12MW for full capacity operation and 2MW for export).

The two turbines are interconnected with a steam header and linked to a condenser to process any excess heat. A heat exchange is

used for cooling the offices in the administration tower and the environmental education centre.

A desalination and water treatment plant (capacity 600m<sup>3</sup> per day) provides all process and potable water to the facility.

At every stage of the process where sludge is potentially exposed to atmosphere, the plant spaces are maintained at negative pressure, and air emission is processed through a centralised de-odourisation system. All air emissions from the flue stack are subject to continuous emission monitoring to ensure defined air-quality standards are met.



8. An aerial view of the STF, showing the remnants of the Pulverised Fuel Ash (PFA) lagoons on which the facility is built.

9. The geological composition of the PFA lagoons.

10. A close-up view of the entrance to the visitor centre (mid-front of the facility) shows the scale of the building and its extensive, newly-landscaped grounds.

Investigation and monitoring was undertaken upon taking possession of the site to determine the selection of the foundation and site formation solution.

The site formation design provided a minimum 200mm fill layer to act as a transition layer and yielded a working platform for the subsequent placement of engineered fill layers that provided the levelling layer to a nominal site formation level of +5.35mPD across the site. This will cap the PFA and provide a stable platform for construction. Where PFA is excavated, such as for the sludge pits, the spoils will be redistributed on the site before the fill is brought in.

Since none of the PFA material could be exported offsite, the nominal site formation level was carefully selected so that PFA could be used as fill in low-lying areas.

Given the likelihood of ongoing settlement and the sensitivity of the process equipment and interconnection pipework between process facilities, piling was selected to mitigate differential settlement as the general foundation system.

The team assessed a range of foundation solutions and decided that driven H-piles were the most appropriate, because they could be installed quickly and mitigated the need to dispose of excavated PFA that would have been necessary for a bored pile approach. The solution offered programme advantages, since the piling equipment could be quickly mobilised and was sufficiently flexible to accommodate unforeseen ground conditions.

8.

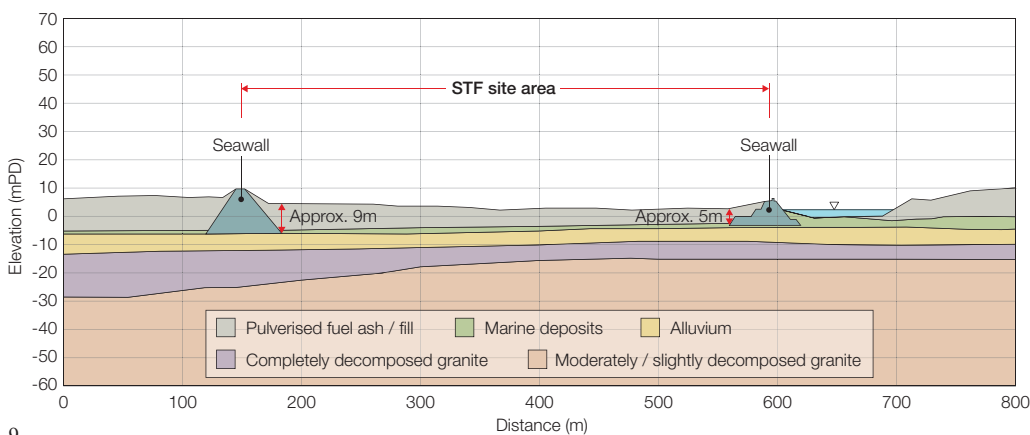

9.

### Sustainability

The STF is highly sustainable. As well as the self-sufficient process, almost 70% of the site is landscaped or has green roof coverage. As a result, the project is striving to achieve BEAM Plus accreditation. BEAM Plus is Hong Kong's scheme for recognising and certifying environmental excellence in building design.

The site has a zero fluids discharge policy, which means that water recovered through desalination is used on site for drinking and industrial processes; treated wastewater is used for vehicle wash and irrigation; rainwater is collected from green roofs and used to supply process water and fire service tanks; and all wastewater is treated on-site for reuse.

### Site formation and foundations

The STF occupies a seven hectare site of the former Tsang Tsui Ash Lagoons. These were formed within reclamation areas bound by a lined seawall that were used for disposal of Pulverised Fuel Ash (PFA) from the adjacent Black Point Power Station and subsequently capped with general fill. Rockhead varies between 35m and 15m below the nominal formation level of +5.35mPD.

The PFA fill comprises uniform density material that was placed progressively over time. It was pumped into place, and the deposition displaced seawater within the lagoon area. The fill material exhibits weak sub-grade strength, with SPT N in the range of 2-6, that degrades when wetted. This forms a specific constraint to 'traffickability' of the formation during construction.

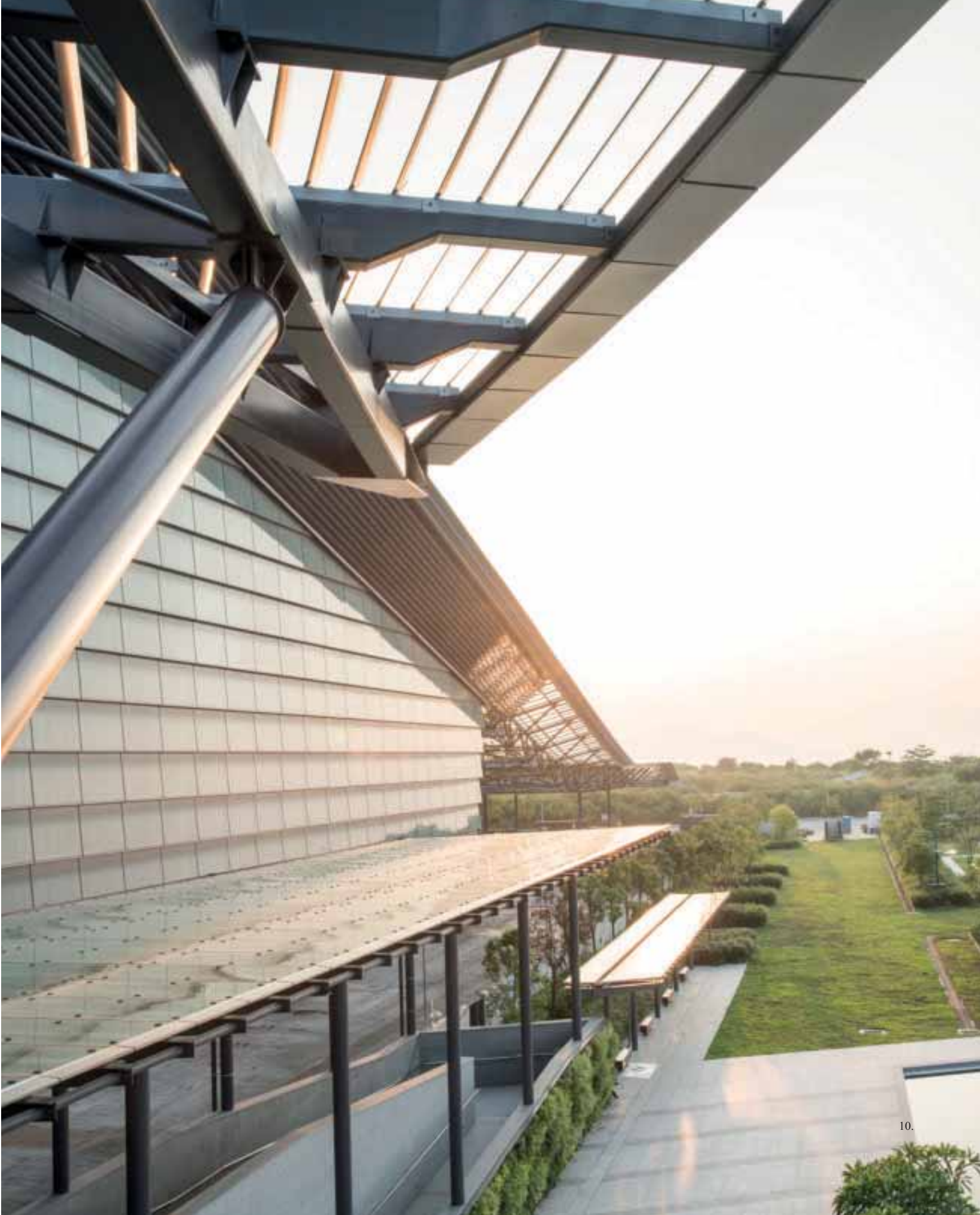

The driven H-piles were driven to refusal (SPT  $N > 200$ ) after pre-drilling to identify the anticipated ground conditions. Pile lengths varied between 15m and 30m and were positioned in groups to resist gravity loadings from the buildings and process equipment. Typically, piles groups and pile heads were stabilised through a raft or ground beams and designed as suspended due to the likelihood of ground settlement.

Placement of driven H-piles within the PFA yielded some durability concerns due to the high chloride content of the PFA within the inter-tidal zone. Arup's research and development team assessed the corrosion environment, and while these assessments determined that the likely corrosion rates were low (from the results of leaching trial tests), it was decided to provide mitigation from corrosion. A 2.65mm sacrificial layer thickness was defined such that the H-piles were sized to yield the appropriate design size after provision of a 50-year corrosion allowance of 0.05mm/year.

#### Landfill gas assessment

The STF lies within a landfill gas consultation zone, and although the risk of landfill gas migration is extremely low (the site is separated from the landfill by a river channel), Arup conducted a landfill gas impact assessment. As a result, a landfill cut-off trench that extends 1m below the groundwater table was formed along the boundary of the facility facing the landfill.

Below-ground tanks such as the sludge bunker, basement level plant rooms and site-wide common utility trench were lined with a gas-impermeable membrane, and below-ground services were routed within this trench or embedded within the concrete suspended slab structure. This meant that no utility services were in direct contact with fill that may be subject to landfill gas conveyance.

#### Common utility trench and pipe bridge

To overcome concerns with respect to the differential settlement of utility services and process pipelines that interconnected the facility buildings, the distribution strategy for all utility services and process pipelines made use of a piled below-ground common utility trench and a pipe bridge that was integrated with the visitor viewing gallery.



11.

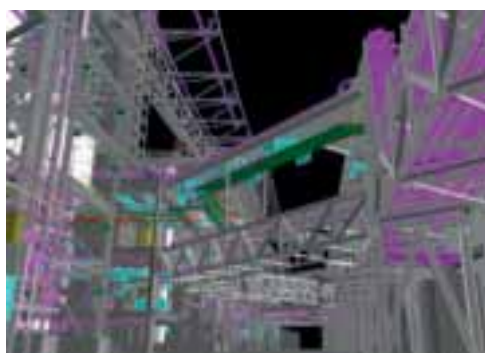

12.



13.

These above- and below-ground corridors enabled distribution of utilities and process lines so that maintenance access and visual inspection was available for all services at all times. This approach also mitigated the need for any special treatment for direct buried services that would be subject to settlement and potential landfill gas impacts.

#### The roof structure

Achieving the dramatic architectural form of the STF roof structure posed considerable design challenges. The 400m-long roof spans over, and unites, the two incinerator plants and the centrally located administration tower, creating a building form very different from a conventional industrial facility.

In the longitudinal direction, the roof height varies from 6m to 35m above ground level so as to reflect the internal usage of the



14.

building, with the highest point housing the main incineration plant. To achieve natural light penetration into the 50m width of the building, a series of varying height north-light roof features project from the roof surface, forming a stepped profile to the transverse roof cross-section.

The architectural vision for the roof was a series of triangular cross-section space trusses, spanning longitudinally up to 50m and with continuously varying cross-section to reflect the varied stepped profile in a transverse direction. It was realised, however, that this could be rationalised without compromising the overall architectural intent by resolving the roof into a series of five planar trusses at 12.2m spacing, with the 6m spacing secondary transverse steelwork used to form the variable height north-light features. This decision improved the 'buildability' of the roof and was key to achieving the overall construction programme for the building.

The detailed design of the continuous planar roof trusses focused on the ease and cost-effectiveness of steelwork procurement, fabrication and erection.

The depth and lengths of truss segments was set so that all truss portions could be fabricated in mainland China and delivered on flatbed trucks directly to the site without police escort. The maximum overall depth of truss was 3m and the maximum segment length was 12m. All connections were site bolted for ease of erection.

The use of Grade S355 hot-rolled Universal Column (UC) sections proved the most cost effective for the chords and diagonals, as well as being the section most readily available in the local market without significant lead time for procurement.

Rotating the chord sections, such that their webs were horizontal and the flanges vertical, meant minor axis buckling lengths

11. The 'dragon's wing' roofline viewed from beneath, and administration building disguising the flue stack.

12, 13. The pipe bridge, as a 3D model and after construction.

14. The roof, built from intricate steelwork, incorporates ingenious windows to daylight the process halls below.

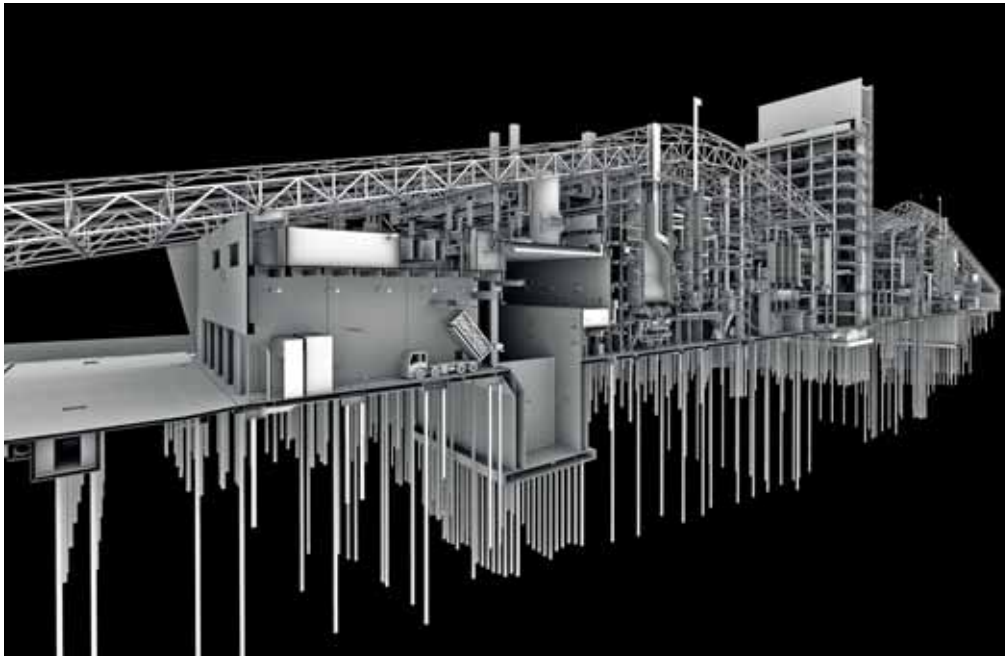

15.

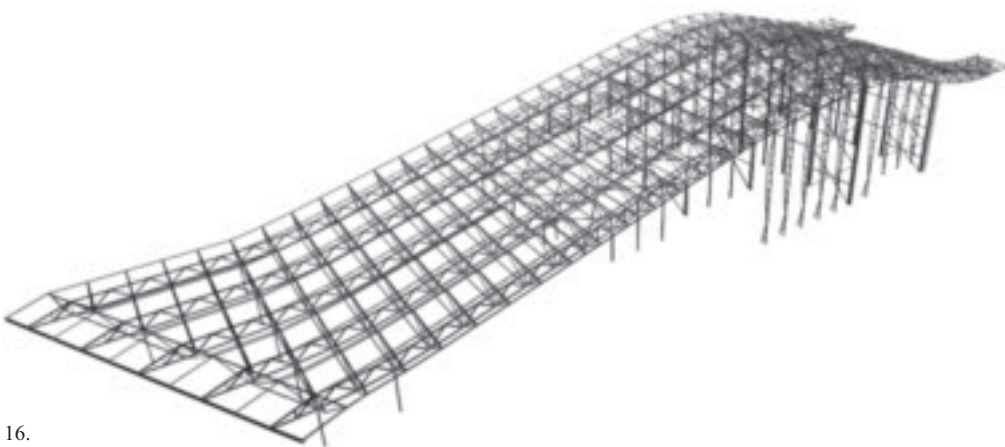

16.

15. Sectional view through BIM model indicating integration of roof with process equipment.

16. The detailed design of the secondary transverse steelwork of the roof proved to be one of the more challenging aspects of the design process.

17. The roof under construction in 2012.

were controlled by the 3m spacing between node points, rather than the much greater 6m spacing between the transverse secondary steelwork. This was the most efficient orientation given the particular arrangement of transverse steelwork and plan bracing opportunities.

The chord orientation and the use of UC sections for the diagonal within the same section range as the chords meant the diagonal flanges could be part-penetration butt-welded direct to the flange edges of the chords. The major benefit of this was minimal stiffeners at connections and hence time savings in fabrication.

Owing to these initiatives, between the end of tender design and the conclusion of detailed design, the team reduced steel tonnage in the roof steelwork quantities, improved 'buildability' and reduced fabrication effort and costs.

The detailed design of the secondary transverse steelwork proved to be one of the more challenging aspects of the design process. The variable saw-tooth external profile was architecturally required to have maximum saw-tooth depth towards the centre of a longitudinal cross-section of the building and to flatten out at the two ends of the building. Thus, the transverse roof profile was constantly changing along the building length.

A further complication was that the lowest points of the saw-tooth profile fell below the top chord level of the primary trusses. A variety of structural schemes was investigated, with the main drivers being the response to geometrical changes and the need to simplify the erection process.

After much deliberation, Arup proposed the use of secondary A-frame trusses connected to the bottom chord level of each truss. These A-frames provided a point of vertical support midway between the trusses that could act as a propping point to the standardised inverted A-frame cladding support assemblies. The latter were essentially supported at their apex directly by the truss top chords, and the two ends could be rotated about this point to achieve the required saw-tooth profile.

With this arrangement, the major plan bracing for the roof could be placed at truss bottom chord in one single plane, making

use of the A-frame secondary trusses as part of the bracing system. Lateral wind loading on the roof at top chord level, together with any top chord buckling restraint forces, follow a load path through the A-frame top assemblies, then into the lower A-frames, and finally back into the main plan bracing level. The main cladding support mullions also connect to the trusses at lower chord level, so this solution for the plan bracing level proved ideal for more than one reason.

Being more than 400m long, the roof is sensitive to temperature changes, and this was a key consideration in the design. The two extreme ends of the roof, which are the lowest points, are supported by the large concrete buildings that house the sewage sludge receiving bunkers. These stiff (and low) concrete structures with many

longitudinal concrete division walls were ideal for conveying the longitudinal wind on the roof back down to foundation level. The main issue was that these stiff end structures would constrain any longitudinal expansion and contraction of the roof due to temperature variations.

The longitudinal profile of the roof, forming a vertical wave-form shape in elevation, led Arup to investigate the beneficial effect of curvature in mitigating any longitudinal temperature-induced forces. A curved element, subject to axial force, tends to react by deflecting out-of-plane, thus reducing the shortening or extension of the element that would otherwise occur. Consequently, this out-of-plane movement would reduce the temperature-induced axial forces.

Unfortunately, due to the large stiffness of the primary trusses, this effect could not be used to any great benefit, and a transverse movement joint was proposed and agreed near the middle of the building. The location of this joint was chosen so that it fell outside of the main waterproofing envelope of the building. Then, if it leaked, the consequences to building operations would be minimal.

#### **Façade support structure**

Arup also designed the main cladding support steelwork, including north-facing glazed walls and walls clad with metal panelised systems. The greatest challenges involved the middle portion of the building surrounding the main incinerator plant, where vertical spans of up to 32m were necessary.





18.

18. Sectional view of the roof.

19, 20. Flue gas treatment area and support steelwork coordination with equipment.

21, 22. Comparison between as-built flue gas duct and 3D BIM model of the same area.

At tender stage, simply supported vierendeel bow-back feature mullions with circular hollow section elements were designed to span this distance, with maximum depth at midspan of around 1.8m. However, during the course of the tender process, the design-build contractor decided to squeeze the overall width of the building by 5m with a view to optimising the building volume and cladding area. As a consequence, the space available for the cladding mullions became substantially less, to the point where they would clash with the main (and fixed dimension) incinerator plant.

The Arup team, post tender, responded to this challenge by looking at alternative spanning arrangements and ways of increasing the section modulus of the mullions to mitigate the loss in mullion structural depth at midspan. The eventual solution kept the vertical span of 32m but introduced base fixity at ground floor level

with moments resisted by connections to the underlying pile caps and ground slabs.

The basic bow-back mullion shape was retained, with a 'pin' joint introduced 6m above ground floor level. The mullions themselves were changed to 152UC sections for inner and outer chords, with small universal joist sections forming the internals as part of the overall vierendeel structural system. Horizontal rectangular hollow section transoms, spanning 6m between the main mullions, provided lateral stability to the mullions, making use of U-frame action to stabilise the inner chord remote from the cladding envelope.

#### **Process support structures**

Designing the process support structure required close liaison between the Arup team, the contractor and the fabricator to simplify construction by devising steel details that suited the fabrication and



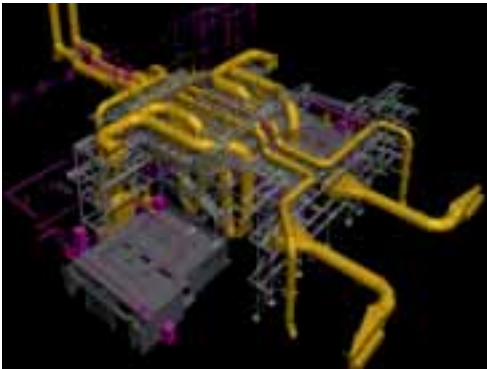

19.



21.

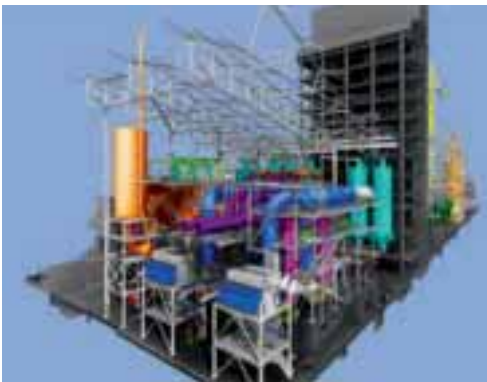

20.

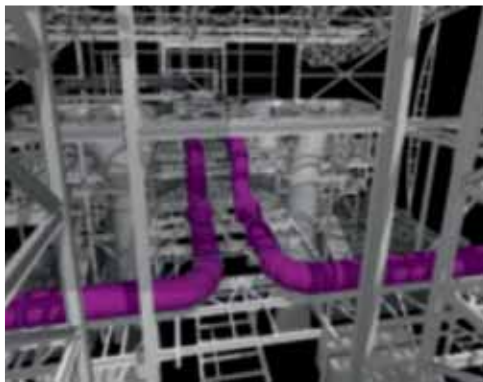

22.

erection process. Coordination with all plant requirements was a major consideration and involved many rounds of clash detection, at increasing levels of sensitivity and resolution, to reduce issues during plant installation.

The first stage simplified the design by eliminating moment connections and reducing the number of bays of bracing. This increased member weight but reduced the range and complexity of the connections. As the amount of stiffeners and thick plates for connection decreased, the effect on the process frame weight was neutral; increased member weights balanced decreased connection weights. However, the cost of fabrication was reduced, because complicated connections are much more expensive per unit weight than simple members.

The next phase of the detailed design was an aggressive process of rationalisation. Steel members were selected from a small range of sizes that the fabricator confirmed were readily available. The fabricator was able to order stocks of steel early and negotiate a better price by ordering larger quantities of each section size. In addition, the number of connection types was reduced, which speeded up both design and fabrication.

Connections all followed simple setting-out rules to reduce the number of variations. Connection plate thickness and size and bolt diameter and pitch were standardised to reduce the number of different types and widths needed. Generally, the connections followed the design rules of the BCSA simple connections guide to allow simple, buildable solutions. Secondary beams were provided with fin plate connections, bracing with gusset plates and primary beams and truss members with end plates.

Bracing connections were often designed, allowing a small amount of eccentricity to simplify the connection design. Permitting eccentricity of the bracing avoids the need for long gusset plates or overlapping members that may be costly to fabricate.

A consequence of simplifying the connections was additional bending in the members, and in some cases this resulted in heavier sections being required. However, the benefit in fabrication and erection offset the cost of the extra steel needed.

When piles supporting the process frame were tested, it was discovered that one of the most heavily loaded pile groups could not achieve the working capacity required in the

process frame design. As the piling contractor had been demobilised, the main contractor wanted to investigate solutions that did not involve adding piles.

The loads on the under-capacity pile group were well defined in the process requirements and could not be reduced; unfortunately, the main silo loads were directly above the lowest-capacity piles. The lower sections of the process frame were already being fabricated, which restricted the options for reducing loads on the deficient pile groups. So the eventual solution was to design a transfer truss at the silo support level.

The stiffness of the truss was tuned to distribute loads to pile groups with lower utilisation, the sensitivity of the truss to varying support stiffnesses was investigated, and a design that could cope with a wide range of foundation stiffnesses was selected. This allowed construction to continue at full speed and avoided program implications as a result of the down-rated piles.

### Clash detection

The purpose of a process equipment support frame is to enable installation and access to process equipment. This means precedence is given to equipment, services and access, with structural efficiency a secondary consideration. This priority made the coordination of plant and structure a highly significant task. The structure was modelled in 3D. Integrated models of all services, plant, equipment and structures were interrogated in Navisworks and clash detection reports were created.

A clash can be hard or soft: hard clashes occur between modelled items, soft clashes occur in an envelope around the modelled element. Detecting soft clashes is important to allow for tolerances or parts that have not



23.

been modelled, such as member eccentricities introduced in the connection design, connection plates or bolts (for the structural model).

Initial reports contained tens of thousands of clashes, but most of these were insignificant. Filtering the reports to eliminate trivial clashes while retaining the important items was a major task.

In many cases, clashes were required. For example, legs of plant items had to soft clash with structural members to allow a connection to occur. So it was essential to place items in appropriate groups and choose which different clash tests to apply, to avoid being overloaded with unimportant results.

As design progressed, the coordination process changed its focus from major plant items to smaller ducts and pipes. At each stage, the initial clash reports contained many spurious items that could be eliminated by improving the clash test rules to discover the genuine issues requiring resolution.

Determining the best solution for each clash required negotiation. There were many stakeholders, and what could be a simple solution for one discipline could be unacceptable to others. All engineers involved had to learn enough about other disciplines to understand which compromises were likely to be possible.

#### **Fire engineering**

As the STF combines industrial facilities with a visitor centre, it presents a unique challenge for fire safety design. In addition, the sludge treatment process involves high-temperature incineration that is new to Hong Kong. Prescriptive fire codes cannot be applied fully to the facility, and therefore fire engineering assessments were conducted to demonstrate the appropriate fire safety level.

Prescriptive code generally requires fire compartmentation to control fire and smoke spread. Travel distances are limited in the code, and automatic sprinkler protection is required throughout any building that is larger than 230m<sup>2</sup>. Such a blanket approach of prescriptive code requirement may not

address the specific fire risk and might result in unnecessary protection measures that are not effective.

A fire risk assessment was conducted as part of the engineering approach. This enabled the team to identify hazards and propose corresponding mitigation measures. An overall fire strategy was developed that considered the life safety of occupants, as well as firefighting and rescue.

#### **Fire and life safety evaluation**

##### **Sludge reception**

Methane gas (CH<sub>4</sub>) and hydrogen sulphide gas (H<sub>2</sub>S) are the two major hazardous materials within the sludge reception and bunker areas. CH<sub>4</sub> released by digested sludge is flammable, but only over a narrow range of concentrations (5–15%) in natural air. H<sub>2</sub>S is a colourless, very poisonous and flammable gas. The tenability limit for H<sub>2</sub>S is much lower than lower explosive limit, so keeping the concentration to maintain tenability will also prevent fire and/or explosion. Other harmful gases such as carbon monoxide (CO) and carbon dioxide

(CO<sub>2</sub>) are less critical once an adequate ventilation rate of 12 air change per hour is provided to dilute the CH<sub>4</sub> and H<sub>2</sub>S.

Therefore, gas detectors are provided to monitor the concentration levels of CH<sub>4</sub>, H<sub>2</sub>S and CO, as well as oxygen deficiency. Infra-red flame detectors are installed for sludge bunkers to provide early detection for fire and investigation and an alternative to a smoke detector. The sludge bunker is designed as an EXplosives ATmospheres (ATEX) Zone due to the presence of CH<sub>4</sub>, and safety design follows the recommendations from IEC EN 60079-10-1.

#### Incineration units

The incineration units are designed and constructed to mitigate the risk of fire spreading from them. Fire-rated refractory lining and membrane wall is inherent in the design of the incinerator to contain any fire hazard. Temperature monitoring and control and pressure relief are fully automated using a Supervisory Control and Data Acquisition (SCADA) system with automatic shutdown in the event of accident.

The SCADA System is provided with 100% central processing unit (CPU) and power-supply redundancy. In addition, an independent incinerator protection system continuously monitors the status of air, flue gas and the flue gas recirculation system as a prevention measure. Other protection measures include constant temperature monitoring and control, negative pressure environment within the incineration unit, pressure relief and controlled shutdown.

#### Incineration hall

This is a very large compartment housing the incineration units. The compartment size and travel distances exceed the prescriptive fire code limits. The fire and life safety of occupants was assessed based on tenability limits maintained throughout the evacuation time. In order to prevent build-up of smoke and heat, mechanical extraction fans were utilised in the smoke extraction system, which is combined with the normal ventilation of the hall.

Smoke spread analyses using Computational Fluid Dynamics (CFD) modelling were conducted to demonstrate the performance of the smoke extraction system. A fast-growth fire of 5MW was assumed as design basis with sensitivity analysis of up to 20MW fire size conducted. The study



24.

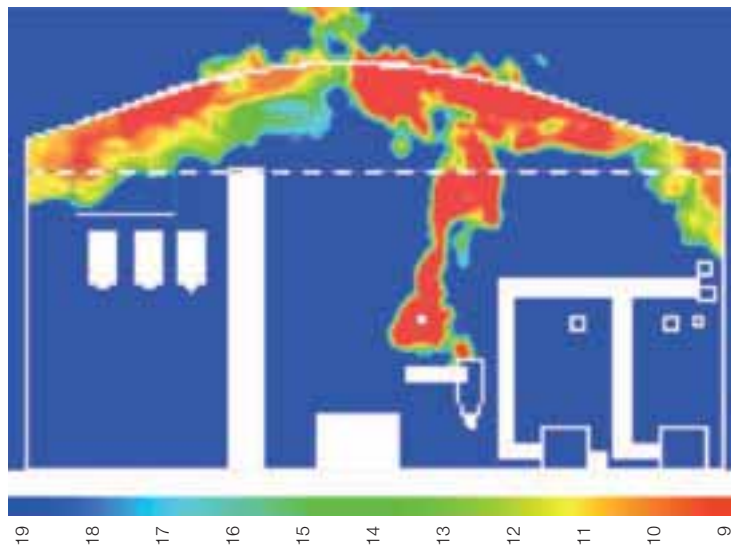

25.

23. Arup's fire engineering team had to develop a strategy that encompassed areas as diverse as this open visitor viewing gallery and the neighbouring process halls.

24. Interior of the incineration hall.

25. Smoke modelling.

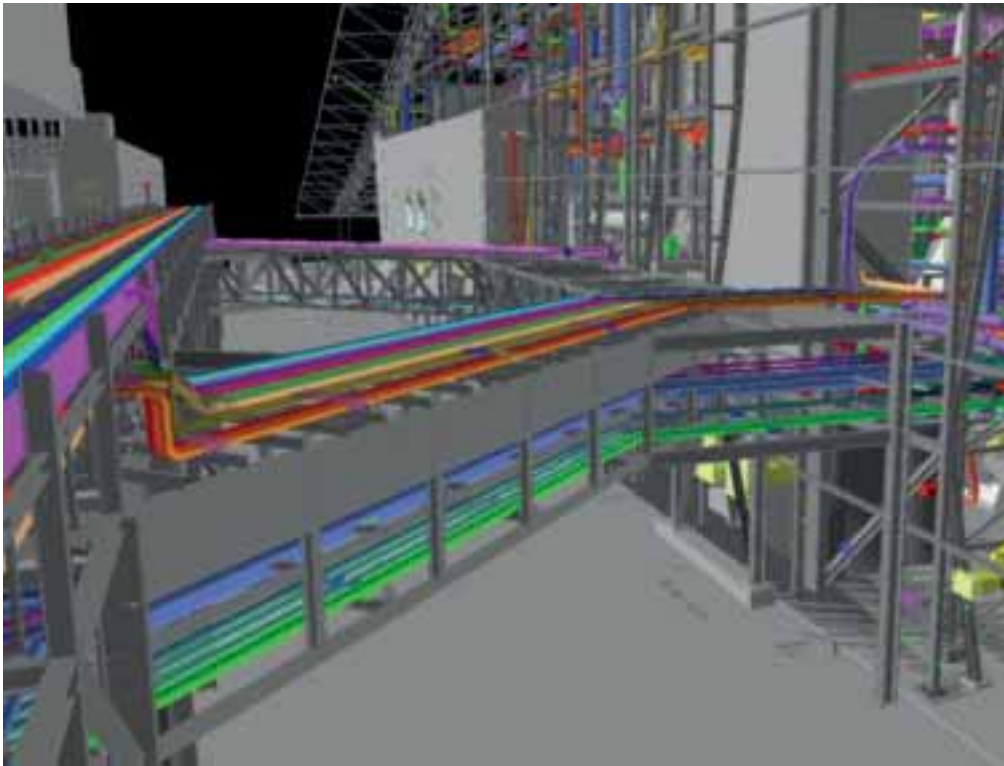

26.

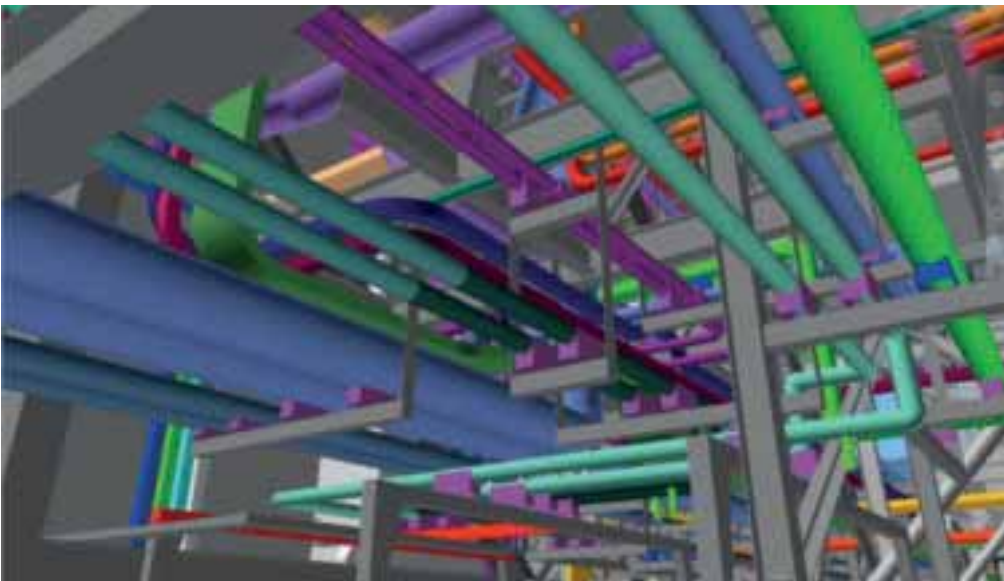

27.

- 26. Pipes interconnecting the two buildings.
- 27. Pipes in a congested area with primary support and secondary (steelwork) supports.
- 28. The sand and lime dosing equipment.
- 29. Soil resistivity was measured in developing the earthing system design.

demonstrated that smoke layer can be maintained at high level and tenable condition can be maintained underneath the smoke layer throughout the evacuation time of approximately five minutes.

The incineration unit comprises large machinery about 20m high. Maintenance platforms are provided around the unit in the incineration hall, including two access stairs, which are enclosed and fire rated for each plant. The escape distances on the maintenance platforms are measured up to 73m, which exceeds the code limit of 30m. Considering the low occupancy number of trained staff present at the maintenance platforms design, an assessment on Available Safe Evacuation (ASET) against Required Safe Evacuation Time (RSET) was conducted to validate staff evacuation in the extended travel distance design.

**Process mechanical design**

More than 1,000 process pipelines are routed around the site with sizes ranging from DN15 to DN1700. The pipes run through a congested environment with complex interconnections. Based on the Piping and Instrumentation Diagrams (P&IDs), pipes were routed in 3D using AutoCAD MEP with architectural and structural models as background. Design of the pipe supports, valves, movement/expansion joints and maintenance access were proceeded concurrently.

Arup prepared a critical line list with fluids at extremely high design temperature and design pressure, such as flue gas at 950°C and feed water at 99 bar pressure. These critical pipes were expected to have thermal expansion and pressure impacts, so stress analysis was an essential task.

Arup carried out the critical lines stress analysis with Bentley AutoPipe. Pipe configurations were reproduced from the 3D model with required accessories in position. Pipe stress behaviour, thermal effect and pressure effect were analysed during the simulations. Analysis results verified the design of pipe material, pipe support, movement joints and/or expansion joint type and location. The results were also used for associated load calculation for secondary structural supports.

Arup benefited by using a 3D model for piping design. Pipe data containing fluid properties, pipe materials, tag numbers and referenced P&ID were inputted to the model when the pipes were first created. Clash detection was accomplished with the aid of Naviswork Manage to ensure pipes were coordinated with other disciplines and running in clear paths. General Arrangement (GA) drawings and isometric drawings were subsequently generated from the 3D model as deliverables. Arup incorporated detailed information into the isometric drawings for material takeoff (MTO), including total pipe length, quantity of pipe fitting, pipe support and movement joint, which were computed from the 3D model. This automated process saved time and minimised human errors compared with the traditional 2D design method.

### Process electrical design

LV distribution cable sizing and other electrical design analysis, such as fault study, earth fault loop impedance calculation and discrimination, were performed on Amtech. This process was challenging due to the complexity of the project and the fluidity of the load schedule and process design, which resulted in the necessity for partial electrical system redesign.

Modelling cable containment in BIM optimised the redesign process and facilitated a more efficient cable containment routing and installation. Clash analysis was performed to locate clashes and facilitate efficient rerouting of design elements in the model. The utilisation of BIM in the design has also proven to be an effective way in assisting with the 2D drawing production of process electrical design drawings.

### Earthing system design

The STF is located on reclaimed land with varied soil resistivity along different soil depth. Site measurement showed that the soil resistivity of the site could be modelled with a two-layer model, with boundary depth at 6m. The earth mat covered the whole site with a span of 270m x 115m. Finite Element Modelling (FEM) was used to model the earth grid and calculate the limits of rise of earth potential, touch potential and step potential to ensure safe operation of the plant.



28.

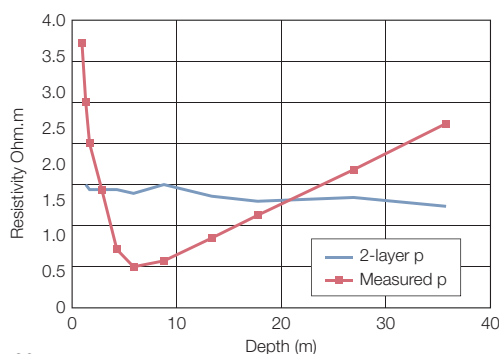

29.

### HV infrastructure, grid connection and synchronisation

The power generated from the STF is supplied into the utility grid owned and operated by Hong Kong's leading power company, CLP. CLP operates a vertically-integrated electricity supply business providing a highly-reliable supply of electricity to 80% of Hong Kong's population.

Arup designed the HV infrastructure requirements for STF, consisting of 2 x 14MW steam turbine generators, 52 x 11kV switchgear panel, 32 distribution transformers, 11kV variable speed drives and

an extensive network of underground cable systems. In addition, a Power SCADA network combines the protection and control functions by implementing the second generation of IEC61850 to provide improved network redundancy underpinned by Parallel Redundancy Protocol (PRP) and High-availability Seamless Redundancy protocol (HSR).

The facility was connected to the CLP Power 11kV network via an onsite grid connection HV switchroom. The two 14MW 11kV steam turbine generators (STG) were sized to meet the total 12MW facility parasitic load requirement with excess power up to 2MW being exported to the grid. A 2MW 11kV emergency diesel generator (EDG) was provided for backup supply to essential services for safe shutdown of the facility at the initial stage and to assist with the start-up of the plant. Provision for installing another EDG at a future stage was provided, with connection to a new CLP 132kV substation to be built near the site.

The power from STF was synchronised with the CLP grid for power import and export through the extension of the CLP network

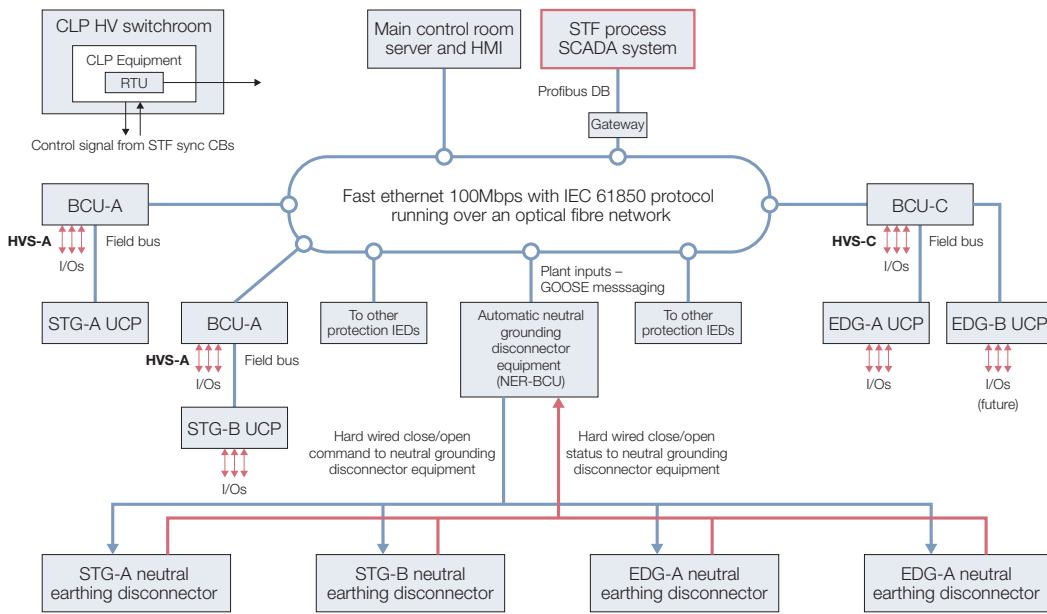

30.

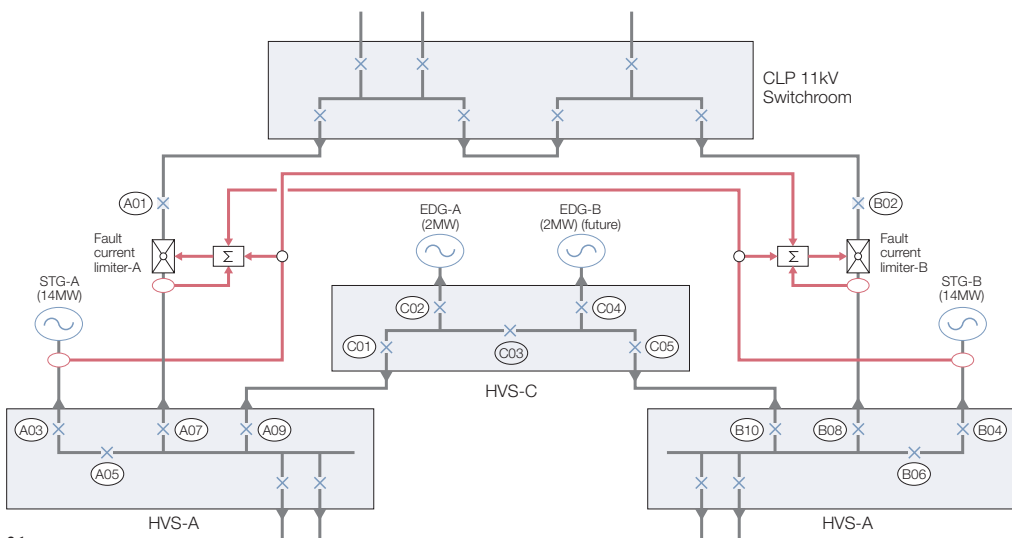

31.

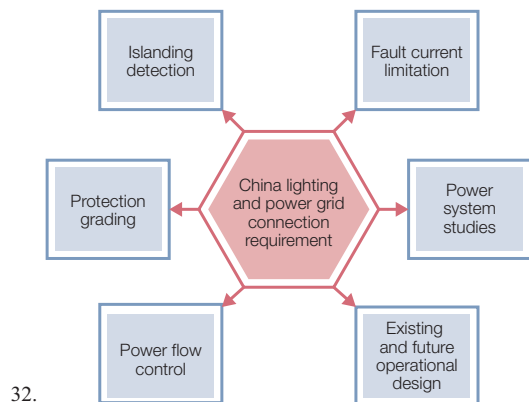

32.

from the local 11kV closed ring. Three incoming cables, each with 7MVA capacity, were installed to the CLP substation at STF with one clean feeder (dedicated for STF) and two dirty feeders (also connected to other CLP customers). Two 7MVA feeders were installed to connect the substation and 11kV switch rooms. Grid connection arrangement was to meet the requirement of fault levels, harmonic limits, voltage variation, power factor and protection, as well as the power exportation and importation limit, which presented a challenge.

Arup conducted the power system studies (load flow, fault study and stability studies) and established the operating parameters to ensure that the grid was not exposed to undue stresses to comply with CLP's limit of 5MW import power flow from the grid and 2MW export power limit to the CLP network through the 11kV connection. These contractual limits were adhered to in STF through the implementation of a three-step hierarchical approach of alarming, controlling and protecting.

In this approach, the operator is first presented with a warning alarm through the HV SCADA control system when the import or export power is approaching the limits and some recommendation of actions to be taken by the operator were proposed. Should the situation persist, load management through an automatic load shedding strategy would be implemented. If that failed, the protection system would trip the two-feeder circuit breaker after a time delay to avoid unnecessary disconnection of the plant to the grid.

Another challenge was to maintain the fault level limit imposed by CLP with three-phase fault contribution from the steam turbine generators limited to 40MVA. Steam turbine generators fault contribution to the CLP 11kV distribution network was expected to be around 100MVA. This exceeded the fault level capability of the existing distribution network assets and caused protection coordination issues at the 132/11kV primary substation.

Out of the commercially available fault-limiting technologies, fuse-based fault current-limiting technology proved the most appropriate technical and economical solution. Also, it provided the improved



33.

protection to generator stator earth faults, enabling it to isolate all generator faults within few milli-seconds. The fuse-based fault current limiting technology was adopted to restrict the generator fault current contribution to the power supply company network for the first time in Hong Kong. This IS-limiter provided only a selective tripping and will only operate for short-circuit faults in the CLP network, but not within the STF, thereby increasing the availability of the generating plants.

With the two generators and two additional diesel backup generators, STF is essentially a power system. Its connection to the grid needed a synchronisation strategy through the utilisation of synchronising check feature on the protective relays of the interconnecting and incoming feeders, as well as their corresponding auto-synchroniser-driven circuit breakers. The synchronising parameters of voltage magnitude, phase angle and frequency are regulated through the utilisation of governor and excitation control systems to ensure that, at the point of common coupling, the deviations are within a safe margin with the CLP grid.



34.

In order to provide a safe interface for both CLP and STF installations, protection has been catered for by means of reverse power protection with backup by a rate of change of frequency protection at the STF to prevent possible STG overload and switch off STF incoming feeders if necessary. Nuisance tripping is avoided under transient condition by blocking ROCOF when STGA and/or STGB are connected and running or when EDG-A is connected and running. Should this fail, the IS-limiters would trip as a loss of main backup protection.

30. Communication system.

31. Grid connection electrical schematic.

32. Grid connection studies performed to satisfy utility grid requirement.

33. The feed water tank room.

34. A desalination and water treatment plant (capacity 600m<sup>3</sup> per day) provides all process and potable water to the facility. The plant's reverse osmosis tubes are pictured.



35.

### **BIM application**

The entire design process followed a Building Information Modelling (BIM) process that established complex three-dimensional models that were used for coordination, drawings production, operational and maintenance simulation, as well as material take-off for the design and construction of the facility.

The scale and complexity of the project meant establishing a BIM Execution Plan that defined the zoning and layering of the models and the respective checking and coordination reviews that were imposed at 30%, 60% and 90% design stage completions.

These reviews were fundamental to the successful application of BIM. By enabling the facility to be viewed in virtual space, stakeholders could examine clashes, operational access, delivery routes and

extraction volumes for maintenance before construction commenced. The design could then be modified to resolve identified issues.

The GSA structural analysis models were linked with the Bentley Structures Model so that the general arrangement and geometry of the structure could be accurately acquired and change easily facilitated between modelling platforms. The model was used to directly extract drawings and piping isometrics, and Arup developed specific scripts to enable accurate development of piping isometrics and material take-off for all fitments and fittings. This enabled the contractor to place precise orders for materials.

The greatest benefit of the model related to the collaboration and coordination of the design. The model became an invaluable tool to facilitate discussions between disciplines and enable rapid resolution and

visualisation of conflicts. The implementation of structured reviews reduced queries and clashes during construction on site.

### **Conclusion**

Hong Kong's waste-to-energy sludge treatment facility combines state-of-the-art engineering with an ingenious architectural approach. The result is a facility that is both sustainable and beautiful.

A key building block in the Hong Kong Environmental Protection Department's sewage treatment strategy, it will play an important role in enhancing and improving landfill life and hygiene, and also provide a steady supply of electrical power to the residents of Hong Kong.



## Authors

*David Pegg*, Project Director, was responsible for overseeing delivery of the project from commencement to completion.

*David Pickles*, Technical Director, was responsible for overseeing all mechanical, electrical, instrumentation and control for the facility.

*Simon Pickard*, Associate Director and Chief Structural Engineer, was responsible for the roof and façade support structure.

*Chris Tidball*, Senior Engineer and structural engineer for process equipment support steelwork.

*Giuseppe Mollica*, Senior Engineer for piping design and performance specification for balance of plant.

*James Sowden*, Senior Engineer responsible for leading all mechanical and electrical engineering.

*Young Wong*, Director responsible for fire strategy and fire engineering.

*Carrie Chu*, Engineer responsible for mechanical systems and BIM coordination.

*Kamal Siriwardhana*, Associate Director responsible for HV grid connection.

*Susanne Sugiarto*, Engineer for electrical systems.

## Project credits

Client: *Veolia-Leighton-John Holland JV* Project owner: *Environmental Protection Department, Hong Kong Government* Contractor: *Veolia Water – Veolia Environmental Services* EPC Contractor: *Veolia-Leighton-John Holland JV* Civil engineering, structural engineering, building services, energy strategy, process engineering, fire engineering, landfill gas assessment, water engineering, geotechnics and management consultancy: *Arup – Davar Abi-Zadeh, Edmond Asis, Sonic Au, Joey Belda, Cassie Bi, Efren Bongyad, David Bradley, Paul Brown, Stuart Bull Jr, Narciso Casanova, Edward Cavizo, Matthew Chan, Kevin Chan, Trevor Chan, Tat-Ngong Chan, Thomas Chan, Edmond Chan, Johnny Cheng, Wallace Cheng, Louisa Cheung, Crystal Cheung, Kin Cheung, Raj Chidambaram, Wing Chiu, Chi-Wing Chow, Angus Chu, Carrie Chu, Jinky Chui, Celsius Chung, Linette Cornejo, Jim Daly, Oliver Davillo, Milagros De La Cruz, Anirudha Deshingkar, Andrew Dickinson, Ngoc Duy Phan, David Eames, Matt Ellis, Chauncey Fan, Aaron Fan, Michael Flory, Siu-Man Fong, Nilda Galvez, Chai Gonzales, Damian Grant, Cheryl Ha, Trevor Hall, Thomas Hatton, Peter Ho, Kenneth Ho, Marco Hsu, Eric Huang, Lewis Hwoi, Rex Ibanez, John Ikoro, Grammy Jiang, Kevin Jones, Jellyn Junio, Yiu-Fai Kan, Stephanie Kember, Kenneth Andrew Kong, Wee Koon Chua, Oi-Yung Kwan, Dennis Kwan, Patsy Kwok, Keyo Kwok, Nelson Kwong, Hillman Lai, Otto Lai, Yuki Lam, Clark Lau, Jeffrey Lau, Jak Lau, Siu-Yuen Lee, David Lee, Emma Leung, Gary Leung, Terence Leung, Cyrus Leung, Alex Leung, Andy Liu, Karl Liu, Rick Liu, Cherry Liu, Eric Lo, Ben Loftus, Shabbir Lokhandwala, Nicolas Ludvigsen, Brian Lui, Marcellus Lui, Mingchun Luo, John Lyle, Raymond Ma, Daniel Mak, Julian Maranan, Andrew Marks, Ian McManus, Don Miller, Donald Miller, Thi Minh Nga Yu, Kate Mitchell, Candy Mok, Giuseppe Mollica, Roy Ng, Coleman Ng, Ka-Yuen Ng, James Ng, Ngoc Ninh Pham, Alex Norman, Robert O'Neill, David Pegg, Simon Pickard, David Pickles, Jeff Po, David Pun, Lily Qin, Le Quynh Pham, Ressen Robles, David Rock, Rowan Roderick-Jones, Randy Salazar, Steve Saunders, Sudhir Shinde, Michelle Shun, Christopher Simon, Peter Sin, Kamal Siriwardhana, Raymond Sison, Jimmy Sitt, David Smith, Howard So, James Sowden, Susanne Sugiarto, James Sze, Nicholas Szutenberg, Johnson Tang, Huu Think Vo, Dave Thom, Chris Tidball, Alex Tolentino, Michael Tomordy, Raymond Tsang, Lewis*



36.



37.

*Tse, Devon Tsui, Priyanka Vardwaj, Vikas Venkatesha, Xuan Viet Khieu, Robin Wilkinson, William Wong, Samuel Wong, Daniel Wong, Andrew Wong, Colin Wong, Dicky Wong, Ambrose Wong, Terry Wong, Ken Wong, Young Wong, Michael Wong, Eric Wong, Stella Wong, Polen Wong, Thomas Wong, Creamy Wu, Andrew Xie, Jason Yang, Peggy Yim, Iris Yim, Tony Yip, Grace Yip, Jacky Yiu, Yuki Yu*

## Image credits

1, 8 *Sky Eye Co Ltd*; 2, 3, 5, 6, 9, 30, 31, 32 *Martin Hall*; 4, 7, 10, 11, 13, 14, 18, 23, 24, 28, 33-37 *Marcel Lam*; 12, 15, 16, 19-22, 25, 26, 27, 29 *Arup*; 17 *Veolia-Leighton- John Holland JV*

35. The STF's extensively landscaped frontage.

36. The sludge reception bays. Lorries drive into these bays beneath a leafy pergola, an element of the building's sustainability strategy.

37. Spa pool within the visitors centre. As well as being intensely practical and highly sustainable, the building is attractive and welcomes visitors.

# The Dr Chau Chak Wing Building

**Location**  
Sydney, Australia

**Authors**  
George Cunha Jorg Kramer

## **Introduction**

Sydney's newest architectural landmark is the Dr Chau Chak Wing Building at the University of Technology, Sydney (UTS).

Arup provided strategic and design expertise in a multidisciplinary role on this new building for the UTS Business School, the first project in Australia for leading international architect, Frank Gehry.

It is a remarkable building. Designed to support the core values and future requirements of the Business School, it

will play an important architectural role in the urban UTS campus, the Ultimo area of Sydney, and the larger context of the city.

Named in honour of Australian–Chinese philanthropist Dr Chau Chak Wing, the building was opened in February 2015 by the Governor General of Australia, Sir Peter Cosgrove.

Arup's wide-ranging brief encompassed civil, structural, façade, geotechnical and traffic consultancy services.



1.

## Overview

The building has been architecturally designed from the inside out, the exterior form reflecting the innovative thinking going on inside. Inspired by the idea of a tree house, Gehry describes his design as “a growing, learning organism with many branches of thought, some robust and some ephemeral and delicate”.

The architecture references its surroundings, with the different façades integrating with different aspects of Sydney. On the east elevation, undulating surfaces of corbelled brick complement the industrial backdrop of the Haymarket area. On the west, gleaming glass wall panels reflect the contemporary city backdrop.

The façade’s irregular form is matched by the shape of the communal, office and learning and research spaces within. Each floor plate is tied to the façade at a uniform distance, creating spaces that mimic the waves of the building’s exterior. This irregularity creates a series of floor plates that are each completely distinct in size and shape.

Sloping concrete columns intersect the perimeter slab edge at various angles, merging and diverging as they weave their way around the building’s perimeter. Architecturally, the building’s internal spaces are maximised, providing engaging environments for its occupants. The balancing, sloping columns required careful design to ensure structural stability.

Due to the irregular and complex geometry of the project, the use of building information modelling (BIM) and 3D modelling to design, document, and construct the project was an absolute necessity. Arup and Gehry understood that a project such as this, in which geometry changes and surfaces undulate in all three planes, could not be easily undertaken using traditional 2D methods.



2.

## The project

Located in Ultimo, Sydney, and bounded by Omnibus Lane to the west and Mary Ann Street to the north, the building sits on a site approximately 35m wide and 70m long. It comprises 12 storeys above ground, with parking for approximately 30 cars provided in a single basement level, along with bicycle parking, services spaces and shower rooms.

Arup was engaged in a full design and periodic site supervision capacity. Construction was awarded to Lend Lease under a construct-only arrangement, and a partial design and construct arrangement. Construction commenced in 2011, topping out of the structure was completed in August 2013, the façade construction was finished in August 2014, and the official opening was in February 2015.

This article focuses on Arup’s role in the project.

## Geology and existing adjacent structures

The ground revealed a subsurface profile consisting of fill, over natural soils, predominantly comprising alluvial clay soils with sand bands, then sandstone bedrock at moderate depth. Initially, ground water levels were recorded at depths ranging between 3.3m and 6.6m from the surface and, later, at depths as shallow as 0.8m.



3.

1. The two façades of the Dr Chau Chak Wing Building, seen from Haymarket, in Sydney.
2. The building’s complex geometry was unprecedented within Sydney.
3. Brick corbel overhangs and ‘turned out’ bricks seen from underneath.

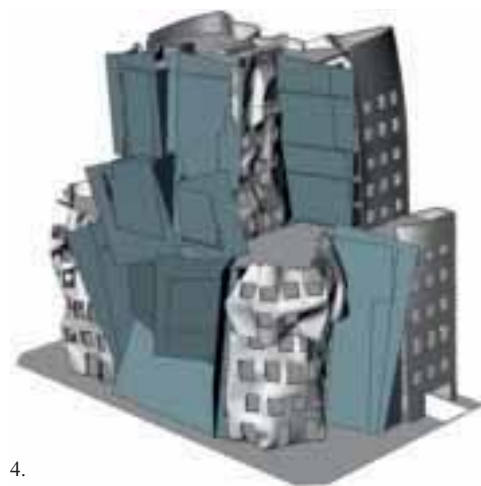
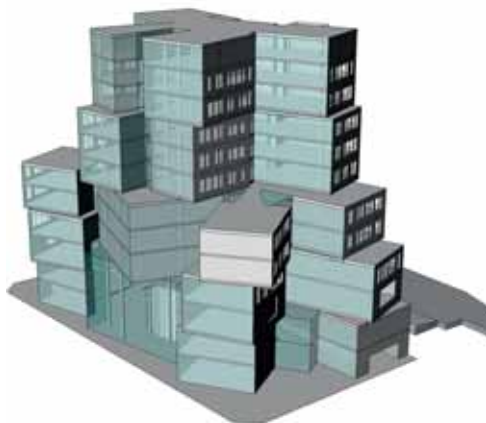

4.

4. The building's form evolved as design concept and structural possibility enhanced the irregular geometry.

5. Seen here during construction, the floor plate had to be able to simply define the variable edge geometry to suit the irregular façade.



5.

The Environmental Site Assessment identified a number of contaminants; for example, some of the fill material was contaminated with petroleum hydrocarbons and polycyclic aromatic hydrocarbons from leaks and spills associated with the underground storage tanks and petroleum arrestor pits that were previously located on the site.

In addition to the challenging ground conditions, there were a number of significant in-ground services adjacent to the site boundary, including the Mary Ann Street Shaft, City West Cable Tunnel and Transgrid Adit Building. Of particular significance was the functioning ovoid sewer located beneath the surface on the eastern side of the site. The sewer was built of fragile masonry and required Arup and the contractor to exercise particular care in design and construction.

### Structure

The structural configuration evolved during the schematic and concept stages, from a 'box on box' form to the final more organic design. This created a structural challenge requiring the resolution of a system of sloping vertical elements and in-plane effects. It was considerably more complex than the 'box on box' concept, which could act as a series of frames to support the floors.

What resulted was a structure that occupies a footprint of roughly 40–60m x 35m in plan; 12 floors of 4 to 4.6m floor-to-floor height above the surface level; a basement level 5m deep; and an overall height approximately 51m above the surface.

The superstructure consists of a concrete-framed building with stability provided by in-situ reinforced concrete shear walls located in the central lift lobby zone, and in the horizontal structure by a system of



6.

post-tensioned banded slabs spanning between columns. Architectural preference was given to a system of perimeter columns, minimising internal columns as far as practically possible. This creates a relatively open interior within the ground, first and second floor spaces on the eastern and western sides of the building. The substructure consists of a piled basement retention system with a suspended basement slab.

### Floors

In order to arrive at a sensible floor system, Arup had to take into consideration some performance requirements. The floor plate had to be able to simply define the variable edge geometry to suit the irregular façade; provide edge stiffness and strength sufficient to support a masonry façade within acceptable deflection limits; internally span a sufficient distance to minimise the number of columns that may inhibit future flexibility of floor planning; be able to, in locations, cantilever long distances within small deflection allowances; minimise overall building mass which would amplify seismic and lateral movement effects; and be economic to construct and familiar to the local market.

Given that the internal loading is relatively light when compared to the external façade, and with less stringent serviceability requirements, it was logical that to achieve

compatible and economic floor plate depths, the column spacing on the façade would need to be less than the internal spacing.

The team settled on column spacing of around 6–7m on the floor plate edges to economically support the masonry façade and, using that same depth of structure, internal clear spans of up to 13m were achieved.

The final choice of post-tensioned banded slab was made after comparing a number of floor construction configurations, including reinforced concrete, post-tensioned flat plate, composite steel and concrete deck, precast beam, hollowcore deck, and even bubble deck.

### Columns

Vertical loads are supported by a combination of walls and primarily circular columns. The geometry of the façade and the associated fixing configuration directly drives the geometry of the structural slab edge and thus the position and inclination of the columns.

The irregular geometry meant that columns became inclined and sloped between adjacent floor slab edges. Although this provided improved column-free internal spaces, it generated in-plane forces at the column-to-slab junctions where inclinations changed.

6. Driven by the irregular façade and structure, some sloping columns separated at high level become merged at lower levels.

7. Seemingly ‘random’ sloped columns helped achieve the architectural vision of large, free, internal spaces.



7.

A strategy to utilise the floor plate band and slab system was adopted to resolve horizontal forces back to the core directly via beams where possible, or in slabs where no direct path was possible. Rules were established to limit column inclinations, both to limit unacceptable movement due to sloping column loads, and to resolve lateral forces back to the core.

Column inclination and column positioning, set against rules of maximum spacing and inclination, developed over time into a seemingly ‘random’ column arrangement, even to the point where some columns which were separated at high level became merged at lower levels.

### Basement shoring, foundations and tanking

Arup took a lead role in developing and clarifying the ground model, giving particular consideration to the costly implications of the high groundwater table and the influence of adjacent in-ground services.

The team was tasked with undertaking supplementary investigation and developing ground modelling that would reduce both the extent and level of basement tanking required. They had to develop a solution that would allow manageable uplift ground water pressures, as well as provide a strategy for undertaking excavation of the basement,

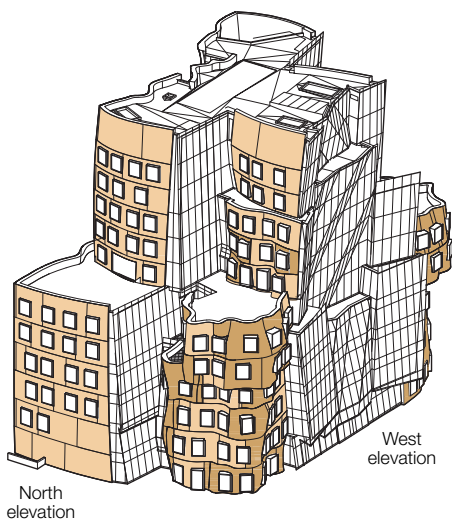

NORTHWEST AXION

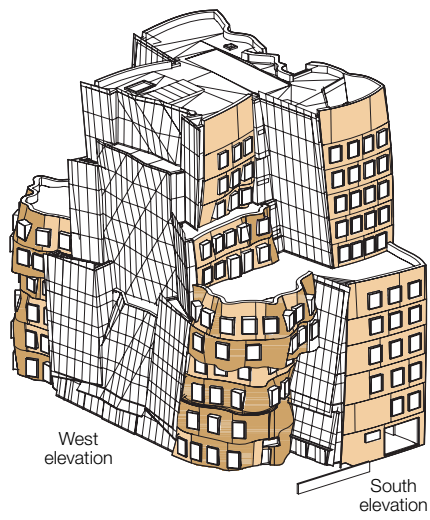

SOUTHWEST ISOMETRIC

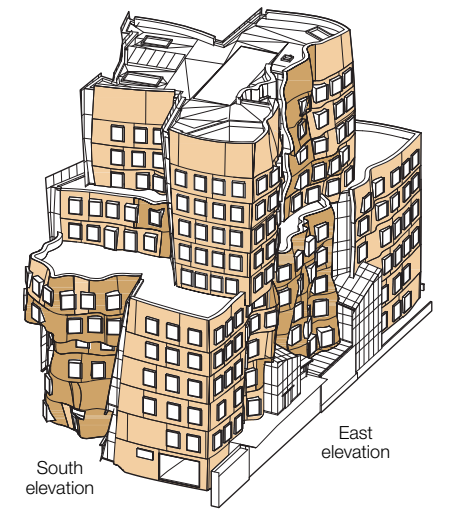

SOUTHEAST AXION



NORTHEAST ISOMETRIC

Brick wall curved:  
 Face brick – corbelled  
 Substrate – curved, inward and/or outward leaning

Brick wall flat:  
 Face brick – vertical or corbelled  
 Substrate – straight vertical and/or tiled

- 8. Within the first and second level void sits the two-storey oval log classroom.
- 9. The oval log classroom features a stacked series of varied ‘log’ elements, each individually affixed to nearby wall elements to ensure stability and serviceability.

adjacent to the oviform sewer, without exceeding its movement limits of 5mm.

So they set about understanding the geology and in-ground environment, and developed justification for a reduced water table and detailed shoring and excavation design and construction methodology for excavating adjacent to the sewer. The basement excavation sequencing was modelled in a step-by-step process which included modelling and designing the installation of diagonal back props and associated movement monitoring and trigger/hold points. Internal diagonal back props were needed because it was not possible to anchor back the shoring walls.

**Oval classroom**

An interesting feature of the building are the two oval classrooms that are situated, one above the other, on levels 2 and 3, enclosed in a ‘Jenga-like’ timber wall structure. This element is located at the entrance to the building within the main atrium space. The wall elements are solid Radiata Pine glue-laminated beams, 450mm wide and 750mm high, varying in length between 2m and 12m.

The two levels were designed and constructed as Timber Concrete Composite (TCC) floors and supported on a structural steel frame. Arup developed the technical details for these TCC floors and associated fixings.

A particular challenge of wall assembly was the timber’s susceptibility to dimensional change over its life – shrinking due to moisture movement within its matrix – and the impact of this movement with respect to adjacent building elements.

To avoid potential impacts on serviceability, the log wall elements were individually connected to adjacent wall elements by a system of screw fixings and isolated from the base structural steel frame. This allowed the two distinct elements of the structure to act independently of each other.

**BIM and structural documentation**

Arup’s team used the 3D BIM modelling software ‘Digital Project’ – the same software employed by the firm on other complex geometry projects such as the National Stadium in Beijing and the Singapore Sports Hub. These projects are both detailed in previous issues of *The Arup Journal*<sup>1</sup>.



8.



9.

The project team drew on Arup's international expertise with Digital Project, and soon learned that the power of the software lay in extension and invention of BIM processes. As their confidence grew, they began to challenge and extend the software by working with Gehry Technologies and Arup's own development teams to formulate scripts that would assist in automating and simplifying processes.

For example, the process of extracting the model output onto drawings was scripted and, once developed, produced high quality construction documentation with minimal post-processing. Another example saw scripts developed to run clash detection on the slab edges, when ongoing adjustments to the façade were being made. These could be easily identified, quantified and the necessary structural modifications made quickly.

The use of BIM on this project provided many benefits to both the client and Arup. During design stage, the model was used extensively for architectural design development, design coordination, clash detection, producing design documentation, and cost measurement and control.

#### **A single element model**

The model was a single element integrated design model, which used parametric links across disciplines. It was hosted on the Tortoise SVN database. The structural geometry was linked 'live' to architectural setout within the 3D environment. Updates to the architecture were automatically applied to the geometry of structure, particularly the slab profiles, column alignments, setbacks and voids.

A process evolved to control these automatic updates using a 'holding area' for change review, prior to incorporation into the master model. This process became extremely robust and efficient, and allowed development and progression of the design quickly and with minimal error.

The interaction of multiple disciplines in a single model was an interesting aspect of the project. As an example, a structural slab had profiles directly controlled by the architect, who oversaw lines in space representing the location of the slab edges or centrelines of columns; voids and setbacks were controlled by the executive architect; and physical model, including structural thickness, column sizes and beams fleshed around or against the architectural lines, was controlled by Arup. This avoided duplication and the associated errors common in modern non-single element BIM models.

For the construction stage, this same master model was passed on to the contractor for use in numerous applications, but primarily for setout extractions, as no setout drawings were provided by the consultants. Construction documentation was delivered in such a manner that day-to-day collaboration and processes needed to be streamlined for quick turnaround between consultants and the contractor. The benefits of scripting work done during the design stage allowed quick construction stage responses.

The model was also used by subcontractors to develop the prefabricated façade backing panels, which were coordinated and



10.



11.

10, 11. The façade incorporates undulating brick, protruding welded aluminium window boxes and sloping curtain wall glazing.

12. Brick substrate panel construction sequence: a. welded steel frame; b. sealed sheet metal skin; c. adhesive membrane applied; d. prefabricated substrate panels on site; e, f. window box inserted and brick laid up on site.

reviewed extensively with few installation issues. This was significant considering that there were challenges such as the fact that no component aligned to gridlines, and more than 800 individually shaped façade backing panels were fabricated.

Arup's excellent partnering relationship with the contractor, Lend Lease – particularly when it came to knowledge-sharing around BIM – was one of the key contributors to successful delivery of the project. In fact, Arup seconded lead BIM manager Rick Benjamin to the contractor to work with them during the construction stage to assist with BIM understanding and delivery.

### Façades

In the initial design, the undulating parts of the façade were intended to be sandstone-clad, in keeping with much of Sydney's built heritage. Arup investigated the capability of local industry to achieve the desired double curved geometry, including stone milling and angle cutting.

Soon into the process, however, the intent changed to brick. This choice was not only more representative of the ex-industrial

history of the area, but also had the potential to highlight the curving forms, with a subtle shadow pattern created by brick ledges. Previous Gehry buildings had used brick for curved façades, but this was the first time corbelling was attempted to create an inwards and outwards curvature.

As this unique application of site-laid brick was seen as a risk to construction programme and labour cost, Arup undertook a wide investigation of prefabricated fixing options. These included brick-faced precast, fibre reinforced concrete and brick tiles, and full bricks supported on steel shelf substructure, amongst others. This was preparation for a two-stage tendering process on performance documents, with the initial documents allowing various options of attachment. It also required a bespoke procurement strategy in order to align with the University's probity requirements.

Following this evaluation, however, it emerged that prefabricated panels and associated jointing would run counter to the architectural vision – to emphasise the artisanal quality of site-laid brick.





a.



b.



c.



d.



e.



The enthusiastic response of bricklaying contractors engaged in the tendering process supported the team's growing confidence that a site-laid brick solution could be achieved and that it could be cost-competitive against the prefabricated options, which would be complicated by other challenges due to the non-repetitive geometry. Arup hence defined concepts to realise a single brick rain screen with curved plan and sectional geometry on a panelised substructure, using corbelling for slopes up to 23° from the vertical.

As this was well outside the applicability of Australian and international standards for brick design, first principle questions had to be considered and resolved, including:

- Overturning moments generated by self-weight of the bricks: these were to be taken out by a higher degree of tying back to the supporting structure. The number of ties was optimised, depending on slope, to limit the cost of custom stainless steel elements.
- Load concentrations on shelves: these occur due to wall curvature, and include aspects such as arching and geometric stiffening effects under movements.
- Spacing rules for joints: these were affected by the geometry, which essentially meant each brick panel had stiffness behaviour in between a flat wall and a corner.
- Special consideration of site challenges, such as setting out and alignment of joints in the shifting brick bond, rules around cutting bricks, and support to leaning walls before setting of mortar.

The final backing structure was made up of panels welded from template-cut steel ribs covered with a flexible thin sheet metal skin. The crucial element was a self-adhesive thick membrane applied over this and continued across slab edges after panel installation. With its self-sealing properties, the membrane supported management of waterproofing risk from the numerous penetrations to attach the brick ties, which would be exposed to water falling off the inward-sloping areas. Arup specified that all penetrations be factory performed, with ties applied on site to pre-installed attachment channels.

Crucially, the behaviour of the brick needed to be considered in combination with that of the substrate. Their differing support and response to movements, such as arching versus panel tipping, differential expansions and different pivot points, all had to be reconciled. Arup formulated rules for movement restraints and releases to accommodate superstructure movements, which proved instrumental in contractor discussions.

Arup's internal advanced technology and research group carried out finite element analysis to prove the structural performance of the brick system in principle. This formed the baseline for later independent verification by the specialist brick structural engineer's models. During construction, positioning of the substrate panels was easily defined via cast-in-slab anchors, and after the substrate was installed and sealed, the position of the bricks was simply measured at a fixed distance from the already curved substrate skin.

#### Materials selection

In parallel with the system development, the material selection process settled on a dry-pressed brick with rich texture and a gold-tan colour, consistent with local historic precedent. In collaboration with the architects, the potential subcontractor and the brick supplier, the process of establishing a range of special shapes for the approximately 320,000 bricks was initiated.

These special shapes create the apparently turned-out cantilevering bricks, visible as features in the constructed façade. They also accommodate positive engagement of ties and joint reinforcement wire, despite the shifting corbel resulting in variable depths of overlap between courses.

With exposure to airborne marine salts from nearby Sydney Harbour compounded by the geometry, which has the potential to capture more water and allow it into the masonry cavity, all shelf angles and custom-designed ties and attachments were made of stainless steel, using the less common Grade 201 to limit cost for non-visible items.

A variety of mock-ups evolved over the course of the project, commencing with various contractor proof-of-concept



13.



14.

13. Corbelling created an inward and outward curvature.

14. Diagonally folded curtain wall on the west elevation.

15. Brick meets glass: this is an exciting new approach to using traditional materials.

mock-ups at tender stage. Later, the team produced visual mock-ups and the weatherproofing prototype, which included brick sections up to two full storeys in height. These brick assemblies were subjected to seismic displacement and various point and area load tests.

Test specimens, particularly those concerned with brick and mortar bond, were employed by the contractor and the specialist brick structural engineer to fine tune mortar composition. This was designed to ensure sufficient bond strength, while allowing the necessary degree of flexibility to minimise cracking.

#### **Curtain walling**

The unitised curtain wall system for the large glazed surfaces had to account for inwards and outwards sloping and extensive ‘fly-by’ cantilevering areas, as well as a variety of interface conditions.

The diagonally folded elevations presented a particular challenge. To avoid kinked panel joints, which would restrict the ability of the system to accommodate building movements, modules were combined into larger panels.

Allowing for movements, including building sway, remained a key challenge throughout the design process. A full-scale seismic displacement test was carried out, which showed that, even in the scenario of joints locking under movements, the flexibility of framing allowed further deformation without detachment of glass.

During the construction phase, in addition to shop drawings, the subcontractor provided detailed 3D models of all façade framing so that Arup could provide review comments within the overall project 3D database, greatly enhancing clarity of the design in complex interface areas. All façade documentation was reviewed in 2D and 3D within BIM, unique for the Australian market.

At early design stage, the multifaceted curtain wall and the 300 window boxes with individual orientations were analysed for sun reflections, which could potentially cause glare to drivers. Arup’s ray tracing-based approach was capable of highlighting a limited number of windows which needed to have their orientation rotated by up to 2° to avoid such rogue reflections, with no adverse impact on the architecture.



15.

The extensive folds, valleys, cantilevers and overhangs of the two façades also required special consideration for façade maintenance access. Arup’s specialists developed a strategy for tackling this with a combination of mobile ground-based equipment and placement of a system of anchors, tracks, walkways and removable davit arms for industrial rope access.

### Conclusion

Working on such an unusual and inspiring design demanded ingenuity and teamwork from everyone involved. For Arup, it was a privilege and a pleasure to be able to develop some unique collaborative solutions using the latest BIM technology and techniques to extraordinary effect.

The building is undoubtedly symbolic of its time and place, located at the heart of Sydney’s growing digital creative hub, a hot spot for innovation. The phrase ‘state of the art’ is often used, sometimes without much justification, yet in this instance it is apt. In design and construction, this building represents genuine innovation and an exciting new approach to using traditional materials such as brick and glass.

UTS Chancellor Professor Vicki Sara said: “The Dr Chau Chak Wing Building is certainly a masterpiece of design and engineering. It is indeed a work of art. But it is much more than that. This building is a symbol of everything UTS stands for – it epitomises our vision to be a world-leading university of technology where creativity and innovation intersect.”

### References

(1) Issue 1, 2009, for the Beijing project and Issue 1, 2015, for the Singapore Sports Hub.

### Authors

*George Cunha* is an Associate Principal with the Building Structures team in the Sydney office. George was the structural team lead and the overall Arup multidisciplinary team project manager.

*Jorg Kramer* is a Senior Consultant with the Architectural Engineering team in the Sydney office. He co-led the façade engineering design.

### Project credits

Owner: *University of Technology, Sydney* Design Architect: *Gehry Partners LLP, Los Angeles* Executive Architect: *Daryl Jackson Robin Dyke Architects, Sydney* Structural, Façade, Civil Engineering, Traffic Consultant, Geotechnical Interpretation: *Arup – Hector Abella, Nur Liyana Ahmad, Christoph Angehrn, Peter Bailey, Rick Benjamin, Monika Beyersdorff, Michael Cavallaro, Thomas Chew, John Collins, George Cunha,*

*Natalie Dumbrell, Gareth Edwards, Shawnee Finlayson, Kathy Franklin, Christoph Gruenaug, Peter Hartigan, Tom Hatton, Simon Hess, John Hewitt, Guy Hollingum, Nathaniel Ko, Jorg Kraemer, Dorine Kuo, Wei Lin, Jonathan Lindsay, Peter Macdonald, Chris Mawson, Bruce Moir, Claire Moore, Chris Neilson, Kai Nelson, Deirdre O’Neill, Kimberley Pepperell, Andrew Phillips, Mark Pickering, Kelvin Robson, Samer Sader, Toni Scott, Karen Seeto, Eric Sekulski, Carol Shi, Nick Simpson, Darren Stewart, Anthony Succar, Sergei Terzaghi, Abdullah Uddin, Henry Vong, Matt Walden, Cyndi Wang, Christa Zacharia, Pawel Zielinski, Jahde Zinzopoulos* Building Services Engineers: *Aecom, Sydney (Mechanical, Electrical, IT, AV, Lighting, Hydraulic, Vertical Transportation)* Fire Consultant: *Aecom, Sydney* Acoustic Consultant: *Marshall Day Acoustics, Sydney* Sustainability Consultant: *Aecom, Sydney* Brickwork Structural Engineer (detailed design and construction): *Aecom, Sydney*.

### Image credits

1–2, 9, 11–14, 16–17 *Andrew Worssam*; 3, 7–8 *Carl Drury*; 4–6 *Arup and Gehry Partners LLP*; 10 *Gehry Partners LLP*; 15 *Arup*.

# Malampaya Depletion Compression Platform



1.

## Location

West Philippine Sea

## Authors

Brian Raine Rene Ciolo  
Andrew Grime Leon Lorenti

## Introduction

The Malampaya deep-water gas-to-power project in the West Philippine Sea provides sufficient natural gas to generate up to 45% of the power required by Luzon, the largest and most populous island of the Philippines.

In July 2015, Arup completed its work on Malampaya Phase 3, the installation of a depletion compression platform (DCP) which lies 200 nautical miles south west of Manila. The DCP is adjacent and bridge-linked to the existing shallow water platform (SWP) at the Malampaya site. The concept design and follow-on (FO) phases of the project were undertaken under direct contract to Shell Philippines Exploration B.V. (SPEX). The basic design and

engineering package (BDEP) and detailed design and procurement (DD&P) stages of the project were undertaken as a sub-contract to the topsides designer, Fluor Daniel Pacific Inc. (Fluor), with SPEX as the ultimate client.

## Background

Arup has worked on the Malampaya Project for Shell since the 1990s. Between 1996 and 2000, Arup completed design of the Concrete Gravity Substructure (CGS) for the SWP under contract to SPEX. The completed CGS was installed in 43m of water following a nine-month construction period in a new build dry dock at Subic Bay, Zambales, Philippines. This work is described in detail in Malampaya, the first

CGS built in Asia<sup>1</sup>. Production from the Malampaya field began in 2001.

The DCP was conceived by SPEX to provide additional gas compression to account for the future expected decrease in well pressure from the field. The DCP will maintain an acceptable rate of gas flow through the gas export pipeline (GEP) until end of field life.

The Malampaya project is very important to the ongoing prosperity of the Philippines. The gas supplied through the GEP feeds three power stations with a maximum generating capacity of 2,700MW. Sustaining the use of natural gas for power generation offsets any potential increase in reliance on coal and fuel oil.

**Arup’s role**

This article presents summary details of Arup’s contribution to Malampaya Phase 3.

In addition to the project achievement, it is notable that the platform is the fourth from the Arup ACE platform product range, which was developed in the 1990s as a result of the firm’s research and development investment in simple reusable solutions for offshore facilities. Arup’s global offshore engineering team continues to develop this solution for fossil and renewable energy applications in the marine environment.

**HSSE**

Health, safety, security and the environment (HSSE) were paramount on the project and SPEX set the following HSSE objectives:

- Aspire for Goal Zero (this meant aiming for zero lost time injuries) and behave in accordance with Shell’s Life Saving Rules.
- Design the facilities such that they could be constructed, installed and operated safely.
- Design systems and facilities such that the method of construction and operations minimises simultaneous operations (a situation known to be inherently higher risk) as far as reasonably practicable.



2.



3.

1. DCP held in position during the final base lowering operation.
2. Offload of a cylindrical lower leg segment at the fabrication contractor’s facility in Subic Bay.
3. Location of the Malampaya field and platforms and the GEP route to shore.



4.

4. Integration of the upper and lower segments of a cylindrical leg.

5. Attachment of a lifting shackle to the pad footing.

6. DCP floating in the dry dock at the fabrication yard in Subic Bay, awaiting tow-out and handover to the transport and installation contractor.

Arup staff were briefed on the project HSSE objectives and trained on the Goal Zero programme, actively participating in the programme by complying with the rules, attending and inputting during safety days, presenting safety moments during meetings, and using the safety observation card system to constructively manage and improve safety, both in the office and offshore.

Arup designed the DCP substructure with safe fabrication and installation as a priority. Examples of this included: the use of a self-installing ACE platform solution which allows for rapid offshore installation without the need for a floating derrick (crane); the repeated use of stiffened flat plate elements in the barge and base which could be readily assembled using down-hand welded fabrication at ground level in the yard; the addition of permanent access steelwork to all critical elements of the structure to facilitate

fabrication, inspection and installation (including the leg, barge-to-leg connection, etc.); tailoring the design to suit the gantry crane at the selected fabrication yard (which minimised the need to use other lifting equipment, traditionally the largest source of accidents); design for immediate installation of a temporary bridge between the SWP and the DCP to allow ready access/egress during installation works, etc.

#### **Project phases**

During the concept design phase in the Houston office, three potential solutions were identified for the DCP:

- ACE Gravity Base Structure (GBS)
- Steel GBS
- CGS



5.



6.

The ACE GBS option was selected because it offered significant advantages: the topsides could be integrated with the substructure prior to leaving the fabrication facility, avoiding the need for a traditional offshore float-over procedure; it would be self-installing, enabling rapid offshore installation without the need for a floating derrick; and, overall, it would be lower cost.

The BDEP and DD&P phases were mainly undertaken at the Fluor project office in Alabang in the Philippines. Arup staff from the Houston, Perth and Manila offices formed an integrated team with local and expatriate Fluor staff to deliver the project. The location provided reasonable access to the fabricator in Subic Bay.



7. DCP during handover to the transport and installation contractor in Subic Bay.

8. DCP held in position during the base lowering operation – view from weather deck of the SWP.

western half. The generalised stratigraphy for the ‘flat’ portion of the site consisted of 0.5m to 6m of carbonate sand overlying 3m to 15m of reef limestone, underlain by approximately 35m of calcarenite. A similar sequence of reef limestone, calcarenite and interbedded carbonate rocks underlies this thick calcarenite layer.

#### Metoccean

SPEX provided the design team with a project-specific report covering all regional metoccean conditions (wind, waves and current). This included data at the fabrication site (Subic Bay), for wet-tow (from Subic Bay to Malampaya) and at the Malampaya site. This data was used to select suitable design parameters for the fabrication, wet-tow, installation and in-place stages of the ACE platform life.

The guiding code sets were used to define the critical return periods (RPs) for each stage of platform use. A ten-year RP cyclonic wind was selected for the one-year fabrication design criteria, a ten-year RP non-cyclonic storm was selected for the three-day wet-tow, and a 10,000-year RP cyclonic storm or seismic event was selected for the maximum in-place condition potentially seen by the platform over the 30-year design life. During the critical stages of floating the platform out from the fabrication yard and installing the platform at the site, tighter weather controls were enforced to prevent overload of key elements.

Forecast and actual weather conditions were closely monitored during construction, transportation and installation of the DCP. Limiting criteria were set to allow mitigation measures to be put in place should the forecast indicate weather in excess of the allowable.

7.

Under direction from SPEX, ISO was selected as the principal design code set for the DCP, which was supplemented by the DNV suite.

The purpose of BDEP was to challenge and ultimately confirm the concept design outputs and prepare deliverables suitable for tender purposes. During the DD&P phase the design was tailored to suit the selected contractors and fabrication location, which was reflected in the final set of design deliverables.

The follow-on phase works were undertaken in the Alabang project office as integrated members of the SPEX construction management team. Arup staff regularly visited the platform fabrication in Subic Bay. In addition, Arup provided technical staff during the offshore operations and visited remote fabrication yards in the Philippines, Malaysia and Canada on behalf of SPEX. Arup design staff from Perth, Houston and London also provided technical support.

#### Ground conditions

Ground conditions at the DCP site were assessed from two detailed ground investigations, the first undertaken in 1997 for the existing CGS, and the second for the DCP in August and September 2011.

From Arup’s perspective, the primary focus of these investigations was to provide information to allow assessment of the geotechnical parameters for use in analysis and design of the proposed foundation system.

The DCP site is located to the northwest of Palawan Island in the West Philippine Sea. The site is situated in an area where a significant thickness of calcareous soils and rocks have deposited in a relatively stable geological environment.

The natural seabed levels under the DCP footprint were assessed to vary from 39m to 43m below lowest astronomical tide. A relatively flat area exists over the eastern half of the DCP footprint, with a ridge feature up to 4m in height crossing the





### **Structural design and documentation**

The DCP consists of a sealed barge structure which is rigidly connected to four cylindrical legs, each of which is supported on individual strut-linked hexagonal pad footings.

The DCP arrangement represents a departure from the previous ACE platforms in that cylindrical rather than truss legs are used, and the base comprises a series of linked pad footings rather than a skirted baseplate. The former change was driven by an attempt to simplify the leg fabrication; the latter change was a result of the site geotechnical conditions imposing more concentrated discrete loads.

The 62 x 42 x 7.5m deep barge was fabricated from a series of stiffened flat plate elements. It was fabricated in six global segments and welded together to form the sealed unit. The barge depth is controlled by the wet-tow/installation phase in which the sealed barge provides the required buoyancy. Weight control during design development (of both the substructure and topsides) was thus a very important component of the design and closely tracked throughout by a dedicated team member.

The challenge with the barge-to-leg connection was to form a joint which could accommodate both the required vertical movement of the circular leg during installation, and form a rigid moment connection at the final design level of the barge, without excessive offshore works. Following numerous iterations the final arrangement consisted of the following key elements:

- (i) Two heavily stiffened collar beams, rigidly connected to the top and bottom of the barge, which encircle the leg and offer



9.

both lateral restraint during installation and moment transfer at the design level. A series of elastomeric bearings were installed between the leg and collar to limit lateral movements of the leg during installation. At the design level, a series of prefabricated steel wedges were dropped into place and secured to close the gap between the face of the locally stiffened leg and the encircling collar beams.

(ii) Vertical and horizontal plates, welded in situ between the barge side plate and locally stiffened leg to facilitate the transfer of vertical shear and local torsion respectively.

Although this arrangement was generally considered to work well offshore, it suffered from tolerance issues due to poor fabrication of the wedges. Future applications of this detail should consider match fabrication prior to load-out of the platform.

Each 3.8m diameter leg was fabricated in Malaysia as a rolled circular section and transported to Subic Bay in two sections.

The challenge for the leg was to provide sufficient local stiffening to transfer the peak design actions while accommodating an access manhole near the base (point of maximum stress) and a manhole near the water line, provide resistance against accidental/operational boat impacts near the water line, and form a rigid barge-to-leg connection at the final barge level (allowing for installation tolerances of the final level).

The challenge with the base was to provide a foundation with sufficient weight to resist global overturning, and a suitable configuration of sufficient flexibility to accommodate the stiff founding stratum. The provision of four 21m x 18m x 4m deep hexagonal pad footings linked by pin jointed horizontal trusses provided lateral stiffness and vertical/rotational flexibility: the empty pad footings could be readily filled with an iron ore slurry to provide sufficient weight and the truss connection facilitated lateral load share during both installation and in-place conditions, while accommodating differential vertical founding levels.



10.



11.

As for the barge, the base pad footings were fabricated from a series of stiffened plate elements. The truss structures were fabricated from sealed circular hollow sections. A refinement of the base design was to size the founding material to resist self-scour in the high velocity local flow regions near the footing corners. Choosing a larger size founding material necessitated additional stiffening of the footing baseplate to resist the peak local ‘mound squash’ vertical loads experienced during the critical overturning condition.

Structural analysis for the project utilised a range of different packages: Oasys GSA was used for all basic structural work; Strand7 was used for all finite element and leg impact analysis; DNV Sesam (and the associated tools) was used for the global in-place analysis of the platform (including the fatigue assessment); and LS-Dyna was used for seismic assessment.

The Alabang engineering team, drawn from the Manila office structural group, prepared Approved for Construction documentation

using Revit and Microstation. Revit was used to create a 3D model of the platform for integration with the Fluor PDMS – which is analogous to BIM – model of the topsides. The integration of these elements facilitated clash detection during design reviews and enabled high level weight take-offs to be compared with the governing manual version. Microstation (linked to the Revit model) was used to prepare the project drawings.

#### Geotechnical design

The local and global stability of the DCP foundation system covered the pre-ballasting condition (ten-year RP environmental event) and the post-ballasting conditions (100-year and 10,000-year RP environmental events). Local checks included bearing (including overturning) and sliding resistance, and global checks included slope stability for the entire base.

The design storm used to assess the cyclic performance of the carbonate sand was taken from published data and re-composed to generate storm events that mimicked real

9. Commencement of installation operation for the temporary aluminium bridge between the SWP and the DCP.

10. Connection of lifting shackle to permanent steel bridge between the SWP and the DCP.

11. Permanent steel bridge on the back of a transport vessel waiting to be positioned between the SWP and DCP prior to the lift.

storm behaviour. Use of these design storms in conjunction with Oasys RANWAVE and the storm loading module within Oasys SAFE showed that the in situ carbonate sand behaved poorly under cyclic loading and had to be excavated and replaced with engineered rock fill.

The engineered rock fill used to replace the carbonate sand was designed to perform three key functions: (i) provide a level surface for placement of the pad footings; (ii) provide a competent bearing stratum with minimal cyclic degradation under the applied storm loads; and (iii) provide a drainage boundary for any potential remnant carbonate sand at the base of the excavation. Item (ii) was considered particularly important as it controls the excess pore pressures generated in potentially remnant carbonate sand during storm events, which affects the stability of the pad footing foundation system and the magnitude of storm induced-permanent displacement.

As noted above, one of the key innovations in the geotechnical design performed was the elimination of a dedicated scour protection layer, yielding savings in procurement and offshore placement. The required size of material to resist scour with the DCP in place was computed using the enhanced flow velocities during the 100-year RP cyclonic storm event, derived from wave tank testing and computational fluid dynamics. The size of material required ranged from 61mm to 183mm, with a relatively well graded profile between these limits. The viability of using this material as both backfill for the removed in situ carbonate sand and to construct the seabed preparation support pads was established early in the project with the potential seabed preparation contractors. These contractors also provided their views



12.

on the achievable placement tolerances at the upper surface of the seabed preparation support pads, i.e. potential size of local undulations and maximum surface angle (tilt).

Following agreement on the achievable local surface profile, geotechnical analyses were performed on the selected material to provide mound squash reactions for a variety of potential hump sizes and shapes. These reactions were treated as loads for assessment of local structural effects on the pad footings.

The geotechnical characteristics of the engineered rock fill material were studied in a specialist laboratory equipped with large scale testing equipment. The engineered rock fill was scaled down to conform to laboratory testing standards. The internal shear strength, interface shear strength and compression behaviour of the rock fill was

established through a testing programme overseen by Arup and the selected seabed preparation contractor.

The pad footing foundation system was assessed to require solid ballast to increase the on-bottom weight of the DCP so as to maintain stability during extreme and abnormal loading conditions. The calculations performed for the full range of potential storm events indicated that a minimum submerged weight of 5,840 tonnes of solid ballast was required to be evenly distributed between the four pad footings to maintain long-term stability of the DCP. This was achieved through installation of iron ore particles which were pumped, in slurried form, from a work boat into the pad footings through pre-installed nozzles. The iron ore particles settled within each of the pad footing compartments to provide the required additional on-bottom weight.

12. Lifting of pad footing within the fabrication contractor's dry dock facility at Subic Bay.

13. 3D seabed profile visualised using multi-beam echo sounding during the seabed preparation pad construction operation.

### Seismic performance

SPEX provided the design team with a site-specific Probabilistic Seismic Hazard Assessment (PSHA). Based on additional data gathered since installation of the Malampaya CGS, a reduction in the seismic hazard was assessed for both the 200-year RP extreme level earthquake (ELE) and 10,000-year RP abnormal level earthquake (ALE) conditions. The project team created a new LS-Dyna model of the DCP based on the site investigation data noted above and the new PSHA. A combined model of the DCP and adjacent SWP was also created, which included the bridge link between the platforms.

Using a time history analysis, the LS-Dyna model of the DCP was used to assess peak barge movements and design actions in the base and legs due to seismic loading. The global stability of the DCP during an ALE event was also confirmed and the global foundation displacements were shown to be acceptable.

Using a time history analysis, the combined model of the DCP and SWP permitted peak relative movements between the platforms to be determined. This result was used to inform the design movement envelope for the sliding bridge connection.

The global seismic stability of the slope adjacent to the DCP was also assessed. It was concluded that the existing slope profile was formed as a result of various high magnitude seismic events in the geological past and thus no instability of this feature would result from further seismic shaking in the design life of the platform.

### Seabed preparation

Seabed preparation activities for the Malampaya Phase 3 project consisted of excavation of the in situ carbonate sand to the upper surface of the reef limestone, removal

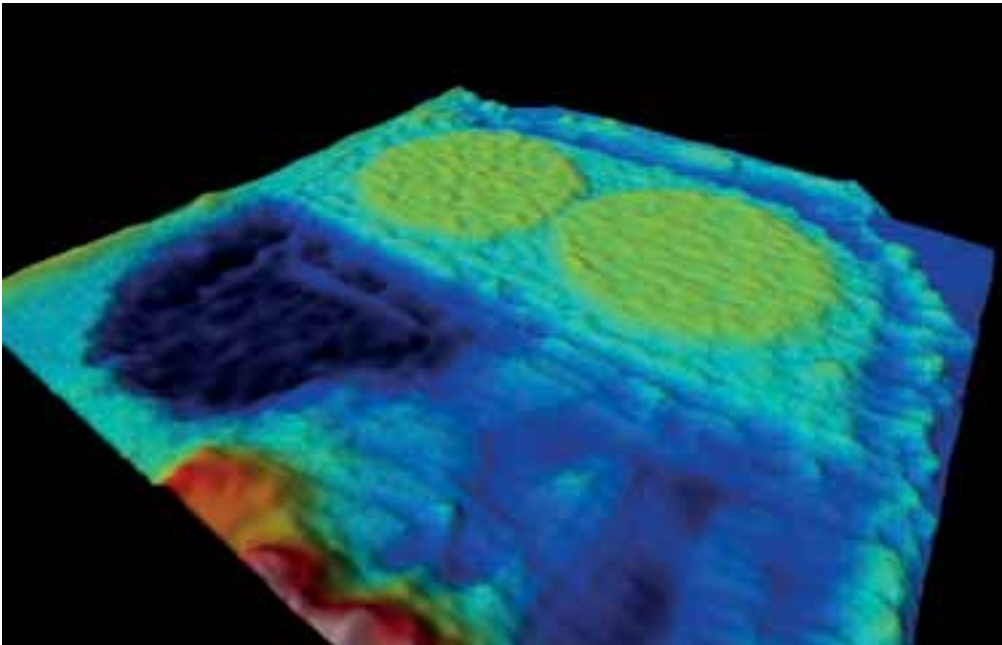

13.

of the reef limestone outcrop (present across the western side of the excavation footprint) and replacement with engineered seabed preparation material to form four elevated pads for placement of the DCP.

Drawings showing the inferred excavation profiles across the footprint of the site were prepared based on the available ground investigation data. The actual refusal criteria which was used to provide sufficient evidence of having reached reef limestone, was assessed from the differential pressure within the contractor's drumcutter, i.e. the difference between the input and output pressure across the hydraulic motor.

Following the completion of excavation, seabed preparation material was initially used as bulk backfill to the general seabed level. It was then used to carefully prepare four seabed preparation support pads at a target elevation which had strict tolerances on the global tilt and the height of any local surface undulations.

Arup managed the contractor while offshore, and continuously reviewed and validated progress of the work in accordance with the specified requirements. The four seabed preparation support pads were successfully installed to the design tolerances, with the seabed preparation material placed onto reef limestone over the full excavated area.

#### Platform installation

Installation of the DCP commenced after arrival at the Malampaya site following the wet-tow from Subic Bay. Upon arrival at the Malampaya site, the DCP was prepared for installation, including activation of the survey, subsea monitoring and jacking systems.

The DCP arrived at the Malampaya site on 9 February 2015 and remained in the wet-tow configuration for approximately three days awaiting suitable sea states. On the morning of 12 February 2015, base lowering commenced, with touchdown occurring on the seabed some 26 hours later. Barge raising commenced immediately thereafter, with the barge clearing the water around midday on 13 February 2015. Barge raising to the required elevation was completed in the early hours of 14 February 2015.

The successful progress of the barge raising, without any indication of binding between the leg and the barge-to-leg connection collar beams, provided further validation of the successful construction of the four seabed preparation support pads and fabrication of the structure to the required tolerances.

Shortly after locking off the barge at the required elevation, a temporary 46m-long aluminium bridge was lifted into position to

#### Key facts

- Barge dimensions 62m x 42m
- Barge depth 7.5m
- Leg diameter 3.8m
- Leg length 81.8m
- Pad footing area 281m<sup>2</sup>
- Pad footing height 4m
- Anodes for corrosion protection 556
- Float-out weight 11,951 tonnes
- Operating weight (including solid ballast) 19,931 tonnes
- Dry mass of solid ballast placed 8,821 tonnes

provide a link between the existing SWP and the newly installed DCP. A permanent 46m-long steel bridge, incorporating gas piping, electrical and other control cabling for platform operation, was lifted into position on 14 March 2015. Arup led the design for the jacked installation of the permanent link span using an adaptation of the DCP lifting technology.

Following installation of the permanent bridge, the lower strand tendons (used for base lowering) were individually hooked subsea by remotely operated vehicle (ROV) and pulled to the deck of an awaiting anchor handling tug and command/storage vessel. It took 15 days of continuous operations to recover and stow the 24 strand tendons.

Solid ballasting of the pad footings was performed following the recovery of the lower strand tendons. Solid ballast was pumped into the pad footings through 24 pre-installed nozzles on each of the pad footings. These nozzles were designed with 'ROV-friendly' latches to facilitate efficient subsea operations. The sequence of solid ballasting was agreed with the contractor prior to the commencement of offshore activities to ensure an even distribution of material both within and between pad footings.



14.

Through the consistent review of the contractor's progress, the solid ballasting work was completed within a month. The measured settlements of the pad footings were in good agreement with expectations, providing further validation of the successful removal of the in situ carbonate sand to the upper surface of the reef limestone over the full required footprint.

Installation and final weld out of the permanent barge to connection, and removal of the upper installation strands, took approximately four months to complete from initial platform installation. Arup provided SPEX with continuous technical support during the process.

### Conclusion

The Arup team successfully executed the self-installing ACE platform substructure from a conceptual solution through rigorous engineering phases, and provided critical engineering support throughout fabrication and installation using a blended local and globally resourced team.

The ACE platform provides an economical and robust substructure for the support of critical energy infrastructure fuelling Luzon Island for another 20 years.

The project delivered the fourth ACE platform and delivered innovation in the form of a high-capacity, high-tolerance prepared foundation without the need for

dedicated scour protection. Also, the use of independent legs and wedged permanent connections provided a benchmark for further development of the ACE platform solution.

Arup's contribution to the offshore works included significant technical guidance and management support to the client team during foundation preparation, platform set down and permanent connections.

As a result of these innovations and Arup's in-depth engineering work, in-place stability of the DCP asset was safely completed less than two days from arrival at site, confirming the selection of the self-installing ACE platform technology.

- 14. DCP departing the Fabrication Contractor's facility in Subic Bay.
- 15. Lifting of the temporary aluminium bridge onto the SWP landing point.



15.

#### References

(1) COLLIER, D, MALAMPAYA: 'the first CGS built in Asia', *The Arup Journal*, 2002, n.1 v.37 (pp 34–39).

#### Authors

*Rene Ciolo* was the Lead Structural Engineer for the project and is based in Arup's Manila office.

*Andrew Grime* is a Senior Structural Engineer and was the Substructure Lead for the DCP. He is currently based in Arup's Perth office.

*Leon Lorenti* is a Senior Geotechnical Engineer. Initially Lead Geotechnical Engineer, Leon was later seconded into SPEX as a Project Engineer providing technical advice offshore. He is currently based in Arup's Perth office.

*Brian Raine* was the Project Director for all phases of the Project and is based in Arup's Houston office.

#### Project credits

Special thanks go to our client, SPEX, who recalled the success of the Malampaya CGS project and provided an environment for the team to succeed. We also thank Fluor Daniel Pacific Inc., which enthusiastically

supported Arup as an integrated member of its Alabang team to deliver a technically superior solution on time and budget.

Numerous Arup groups, particularly the Manila office, supported the involvement of their staff on the project, either by relocation to the Alabang office or by ad hoc support. We could not have delivered such a unique project without them. *Arup staff – Faux Abad, Ian Ashcroft, Alfredo Bautista, Michael Bieganski, Gerrardo Bonagua, Arnie Borreros, Phil Bramhall, Natalie Brush, Ronald James Calairo, Claire Caparas, Simon Cardwell, Ricky Cayanan, Dongdong Chang, Garry Chavez, Rene Ciolo, David Clare, Katie Cook, Steven Cook, David Dack, Martino Dominguez, Mike Dowling, Sarah Elkhatab, Peter Fobel, Kathy Franklin, Graham Gedge, Barnali Ghosh, Richard Gibbins, Brian Glover, Adrian Goh, Damian Grant, Andrew Grime, Claire Heumann, Chris Humpheson, Gordon Jackson, Ben Kelley, Matilda Kitou, Christopher Kubes, Peter Lees, Leon Lorenti, Ziggy Lubkowski, Raul Manlapig, Matteo Minno, Chris Murgatroyd, Rey Noo, Jasvinder Opkar, Nick O'Riordan, Bernard O'Shea, Emerson Palma, Jared Pamor, Stuart Pearson, Darah Pineda, Rod*

*Pinna, Daniel Powell, John Powell, Nadine Radburn, Brian Raine, Abner Ramos, Abs Delos Reyes, Archie Ricablanca, Maria Angela Rivo, Jenny Sandford, Audrey Santacaterina, Mark Skinner, Rob Smith, Ertan Sonmez, Emma Steer, Edward Stonehill, Damon Sunderland, Somchat Suwan, Amir Tabei, Claude Tan, Edmond Tang, Payman Khalili Tehrani, Glynn Thomas, Borbala Trifunovics, Karlo Tubalinal, Jomel Uy, Boc Victa, Chris Villanueva, Tom Wilcock, Tim Wiley, Michael Willford, Colin Williams, Eleonor Ybasco, Hao Yuan, Cesar Zamora.*

Also, we thank *Glynn Thomas*, a former Arup staff member, who relocated to and led the Alabang team from mid-2011 for four years, providing technical and commercial leadership culminating in the successful installation of the platform at site.

#### Image credits

All photographs: *Arup; Shell Philippines Exploration B.V. (SPEX); Mario Babiera – Photo Synthesis Inc.; 3. Martin Hall.*

# Galecopper Bridge

## Location

Utrecht, Netherlands

## Authors

Sander den Blanken Frank van Berge-Henegouwen  
Pat Moore Daan Tjepkema Dimitri Tuinstra



1.

1. Aerial view of the Galecopper Bridge: this project has increased the number of traffic lanes from 10 to 12.

2. The Amsterdam–Rhine Canal is one of the busiest shipping routes in Europe. Raising the height of the bridge to accommodate taller barges was an important aspect of the project.

## Introduction

The Galecopper Bridge, one of the busiest in the Netherlands, has carried an increasing weight and volume of traffic since it was built in the early 1970s. The cable-stayed steel structure forms part of a 12-lane motorway over the Amsterdam–Rhine Canal, an exceptionally busy route linking The Hague with Rotterdam and the German border.

Around 200,000 vehicles cross the bridge every day, a large proportion of them lorries transporting freight to and from the port of Rotterdam. Also, as The Hague is the Netherlands' seat of government and a densely populated urban area, there is a large volume of daily commuter traffic.

Pressure on the bridge became significantly heavier in the 1990s when the haulage industry started to switch from lorries with twin tyres to what are known as 'super singles'. Single tyres reduce friction with the road surface, thus lowering fuel costs, but increase force exerted on a surface by spreading the same weight over a smaller area. By the end of the 1990s, metal fatigue was causing cracks to appear in the steel deck of the Galecopper Bridge and the asphalt on its surface.

Rijkswaterstaat, the Dutch highways authority, needed an urgent solution for the Galecopper Bridge and seven other steel bridges afflicted with the same problem. So the authority turned to Arup and the Dutch consulting engineers RoyalHaskoningDHV for advice.



### The brief

Strengthening the Galecopper Bridge was a high priority for the Rijkswaterstaat team. In addition, they wanted to lift the bridge deck to enable larger container barges to pass under it and widen the carriageway, by a lane on either side, to prepare for the planned widening of the Utrecht ring road.

However, decision-making relating to the ring road had not yet been completed in 2013, so they focused, instead, on the strengthening work, to make the structure robust enough to be widened in the future. The aim was to lengthen the life of the existing bridge by 30 years.

The method chosen was to install four strengthening steel box girders either side of the bridge, each 320m long and weighing 1,500 tonnes. This major renovation programme required new piers and foundations to be built directly adjacent to existing foundations or through existing pile caps, yet foundation installation was tightly restricted by low headroom and proximity to the canal walls and foundations.

Rijkswaterstaat wanted a design solution which would allow new foundations to be built around and under the existing structure, and installation of the strengthening girders, while keeping the motorway network open to traffic throughout the works.

### Arup's role

Arup was appointed as managing contractor for the renovation of the Galecopper Bridge, and the other seven bridges afflicted by metal fatigue, collaborating on an equal basis with RoyalHaskoningDHV on the studies that preceded the work; planning the programme of work; appointing a contractor, and delivering the project.

Arup's role specifically encompassed the technical design of the modifications to the bridges and the quality control involved in replacing the asphalt surface with High



2.

Strength Concrete (HSC), an important innovation within the project.

RoyalHaskoningDHV was specifically responsible for process, traffic management and supervision of the works.

The construction consortium, Galecom, comprised Volker Wessels, Mercon and Hollandia, with CT de Boer, as partner of the construction consortium, responsible for jacking up the bridge.

This article focuses on Arup's work on the Galecopper Bridge, the fourth to be renovated in the Rijkswaterstaat's programme. The project was completed between 2013 and 2015, and its unique challenges demanded equally unique technical solutions.

### The structural problem

The Galecopper Bridge deck rests on a grillage of girders installed at right angles to one another to keep the structure of the deck as light as possible. An important part of this structure are the steel troughs that run across the entire width of the bridge and are welded to the bottom of the steel deck.

During construction in 1970–74, the straight edges of the troughs were not prepared in such a manner that allowed a good welding connection to the deck plate. The weld, located on the outside of the straight edges, caused undesirable 'stretching' of the steel deck, resulting in metal fatigue and cracks that have led, in turn, to spider's web-like fissures in the asphalt that lies on top. The asphalt became detached regularly, necessitating emergency repairs.



3.



4.



5.

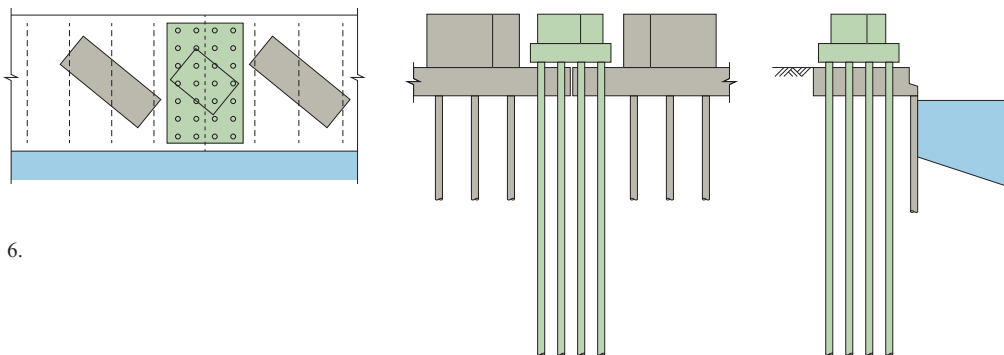

6.

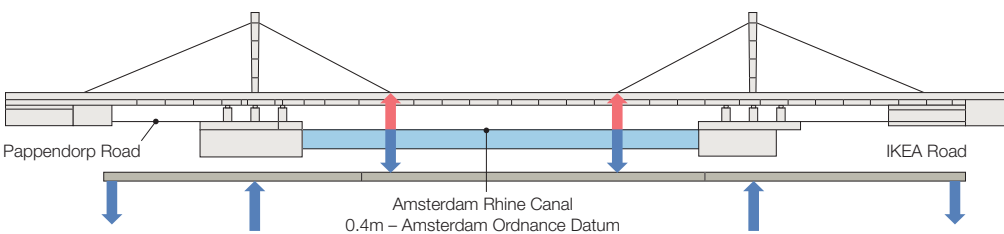

7.

3. A 350m-long tent covered the full length of the bridge so that HSC could be applied under the necessary controlled conditions.

4. Fissures in the bridge deck, indicating metal fatigue.

5. Installation of the grout injection piles in segments due to limited work space.

6. Design sketch of the new foundation by the existing pile cap, independent of the existing foundation.

7. Prestressing the existing bridge.

Rijkswaterstaat wanted to reinforce the deck of the Galecopper Bridge with HSC. The disadvantage of this material is that it is heavier than asphalt, which meant the structure of the bridge would need to be additionally reinforced. The advantage is that it is much stiffer than asphalt and thus spreads load over a large surface area. HSC thereby prevents the pressure of 'super single' lorry tyres from being concentrated on a single trough, thus preventing new cracks from forming in the steel deck as a result of metal fatigue.

However, renovation of the bridge deck was not, in itself, sufficient to extend the service life of the Galecopper Bridge by 30 years. The bridge must also be raised to accommodate inland waterway vessels on the Amsterdam–Rhine Canal.

To achieve optimal utilisation of capacity, these vessels carry four layers of containers where possible, whereas three layers were more usual in the past. The Galecopper Bridge, built 8m above Amsterdam Ordnance Datum, was not designed to accommodate the height of four containers stacked one on top of the other. The bridge therefore needed to be raised to Rhine navigation height at 9.9m above Amsterdam Ordnance Datum.



8.

8, 9. Pre-stressed girders were transported to the site by barge, then lifted into place by crane.



9.

### The foundations

Initial calculations showed that the planned modifications to the bridge would make the structure considerably heavier. Investigation by Arup showed that the existing foundation could not bear the extra load. The capacity of the foundations underneath the four pylons of the bridge was 90% loaded by the existing structure, and this was clearly insufficient to bear the load of the planned modifications and the ever-increasing traffic volumes. The foundations on the outsides of the bridge were 60% loaded.

Arup's geotechnical teams conducted a soil survey to find out whether the existing foundation could be reinforced and, if so, how. They needed to find out whether the soil and deeper-lying sand layers could bear the extra load of the new foundation. But the investigation was complicated by the foundations of an earlier bridge, built in the same place. This meant drilling test boring to depths of 35 and 45m.

After gathering sufficient data and conducting detailed analyses, the team concluded that by designing the new foundations for the strengthening girders to be as stiff as possible, they could prevent the new foundations from affecting, and potentially destabilising, the existing foundations.

Having decided this, they needed to work out how to install the foundations in the very tight workspace beneath the existing bridge deck, without closing the bridge.

The solution was screw grout injection piles, which would meet the site constraints while minimising risk to existing infrastructure. The foundation piles are designed such that they do not transmit pressure from the weight of the bridge directly to the underside of the pile. Instead, as friction piles, the pressure is distributed over the full length of the foundation pile, giving the foundation the desired stiffness.

The foundation piles were installed underneath the existing piers by drilling holes in the pile caps, then drilling the new foundation piles through the holes. The new piles were set down on a sand and clay layer far deeper beneath Amsterdam Ordnance Datum than the sand layer on which the existing foundation was standing. This was to prevent the existing foundation piles from becoming overloaded and losing carrying capacity.

To prevent settlements of the new foundations affecting the existing structure above the existing foundation. Oversized holes for the foundation piles and a gap between the pile caps allowed the new

structure to move freely from the new foundations.

### Steel strengthening girders

The use of prefabricated steel girders, produced in a factory and delivered on pontoons, made the work easier to plan and kept traffic disruption to a minimum.

The structural advantage of strengthening girders was that they increased the load-bearing capacity of the existing structure without radical modification. The four box girders were each connected to the existing structure at two points. After installation, cable anchorages were used to pull the girders downwards at the abutments.

This was to overcome the uplift force at the abutments. The strengthening girders relieve the existing bridge of permanent loads and increase the stiffness under traffic loads. Furthermore, the Galecopper Bridge, which has sagged over the course of the years, is pushed upwards by around 0.2m by the strengthening girders.

The greatest challenge in designing the four strengthening girders was the very tight tolerance within which they had to be built.

The girders are each 326m long and installed in three separate sections. They deviate by no more than 500mm in shape. Due to the



10.

very limited space available, the two girders between the bridges are more slender than those on the outside: the space between the girders is no more than 100mm at this point.

To enable Rijkswaterstaat to build extra traffic lanes on the prestressed girders on the outsides of the bridge, the top of the strengthening girders must be at precisely the same height as the steel deck of the existing bridge. Yet there was little margin on the underside of the girders because ships navigating the Amsterdam–Rhine Canal required extra space to pass beneath the bridge.

In order to design and construct within the very limited margins available, Arup developed a model to accurately calculate the deformations of the strengthening girders, which was used at every stage in the construction process. This was important because during construction in the factory and installation on site, the girders deform under the influence of factors such as their own weight, the jacking and, after the girders are affixed to the bridge, the load of the existing structure.

To keep traffic disruption to a minimum, in a single night the strengthening girders were coupled to the existing structure and the bridge was jacked up,

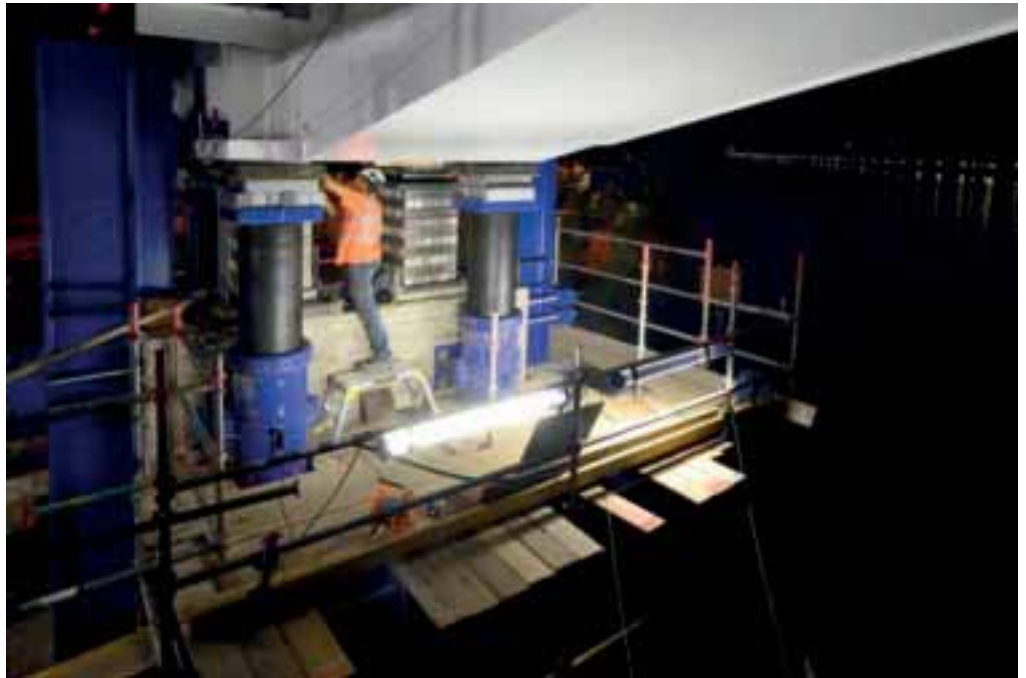

11.

#### Raising the deck

After the installation of the strengthening girders, the bridge deck was raised further. To make that possible, the bearing system of the bridge needed to be modified.

The bridge crosses the Amsterdam–Rhine Canal diagonally. In the original design, the steel deck rested on six longitudinal beams, which in turn rested upon the piers and abutments. The beams were each affixed to the piers in couples using two bearing points. The bearing points did not follow the diagonal line of the Amsterdam–Rhine Canal; instead, they are installed in pairs, perpendicular to the span direction.

The configuration of the bearing points at an angle to the canal gave rise to high stresses in the original structure on the six steel beams that carry the steel bridge deck. This was because one bearing had to carry a high compressive loading, whereas tensile forces occurred in the other bearing. Furthermore, the bearing configuration did not allow for the rotations required for the raising of the deck.

Arup engineers decided to modify the bearing system such that only three of the six original bearing locations were retained. To achieve this, one new bearing point was installed between the two support beams under the bridge.



12.

In the new design, the bearing points were aligned with each other, run parallel with the Amsterdam–Rhine Canal, and are located as close as possible to the expansion joint. This eliminated the concentrated stress caused by the old bearing system.

The new bearing configuration also allows the bridge deck to rotate freely at the abutment during the raising of the deck.

The process for installing the new bearings – and removing the existing bearings – involved jacking up the central section of the bridge for six hours, each night, over a period of several days. The bridge deck, the pylon and the strengthening girders were jacked up individually and the work was scheduled such that the bridge was open to traffic during the day.

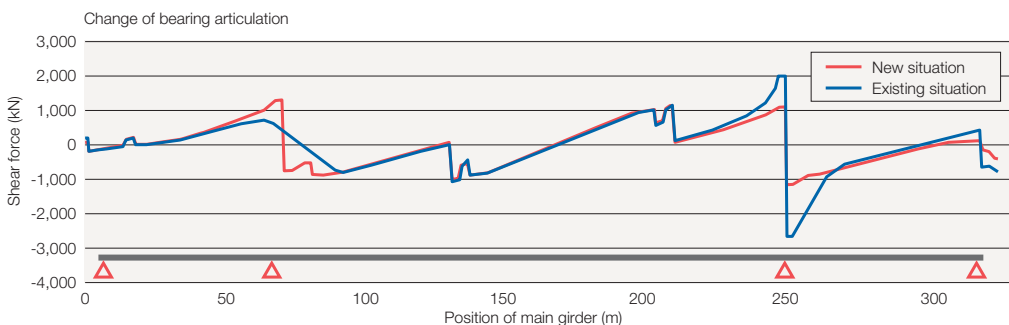
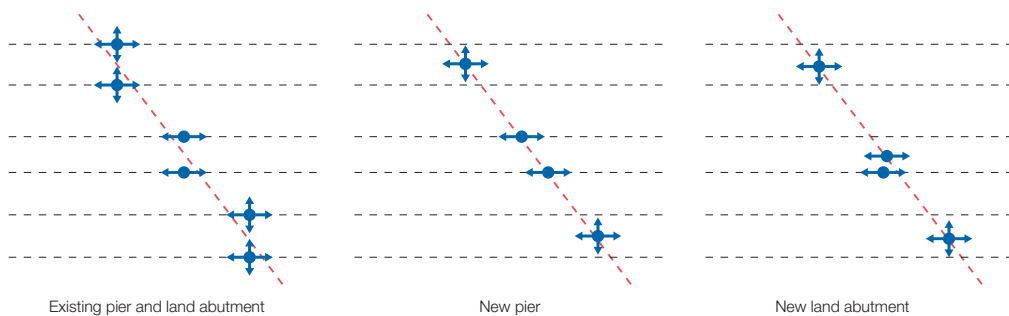

13.



14.

### High strength concrete

When Rijkswaterstaat was deliberating over how to solve the problem of the eight bridges affected by metal fatigue, little information was available about the application of HSC as a deck layer. Yet the highways authority was convinced HSC could be a good solution.

This was because they realised that the replacement road surface would have to be light in weight compared with a traditional concrete surface, which would need to be approximately 150mm to 200mm thick to provide sufficient strengthening, making the bridge very heavy, and the strengthening of the substructure and foundation very

- 10. Interior of a girder during production.
- 11, 12. Jacking the prestressed girders using long jacks.
- 13. Changes of the bearing configuration reduce forces in the existing girders.
- 14. HSC was applied to the bridge deck under cover.

expensive. An HSC surface could be much thinner. The HSC which has now been laid on the Galecopper Bridge is only 85mm thick.

Rijkswaterstaat started its own research into the use of HSC back in 2003, on the first bridges in Moerdijk, Caland and Hagestein. By 2009, the team had gathered enough knowledge and experience to commission the reinforcement of the Muider Bridge at Almere with the aid of its newly developed HSC technique. This was the first bridge of the eight in the current programme which needed reinforcement. Arup and RoyalHaskoningDHV used the same technique on the Galecopper Bridge (the fourth in the programme), monitoring and coordinating the quality and execution on behalf of the client throughout the entire process.

### Resurfacing the bridge

The process for applying HSC is interesting. At the Galecopper Bridge, the existing asphalt layer was removed, then the contractor erected a 350-metre-long tent over the full length of the bridge so that welders repairing the cracks in the steel deck could work in rain, cold or high winds and the HSC could be applied under the necessary controlled conditions.



15.

Before work began, the steel deck was closely inspected with the aid of x-rays and ultrasonic waves. Small cracks were gouged away and welded up, and large cracks were cut out and replaced with new sheet steel. An 85mm steel edge was affixed on either side of the lane. The HSC was to be laid between these edges which were tuned to accurately control the thickness of the concrete overlay.

When all steel deck repairs were completed and the edges tuned, the deck was shotblasted clean with steel balls to create a rough surface for the application of an epoxy layer and crushed calcinated bauxite. This bonding layer was necessary because HSC does not adhere well to steel.

After the epoxy with bauxite had cured, a network of reinforcing bars was laid on the bauxite. The bars are 12mm thick and they were spaced 75mm apart on temporary

supports to be cast into the concrete at the correct height. Concrete was then poured over the reinforcing bars and vibrated to the desired thickness using a 'paver', a machine with a large number of vibrators.

The paver ensured that the mix, which also incorporates steel fibres to limit the probability of cracks forming when the concrete cures, ran smoothly along the reinforcing bars, which are packed together relatively tightly. An average of 20m of HSC was laid per hour on the Galecopper Bridge using the paver.

The HSC was smoothed immediately after the passage of the paver and covered with plastic membrane, then after four days the membrane was removed. Finally, to create a sufficiently textured surface to the HSC top layer for cars and lorries to run, a layer of epoxy with bauxite crushings was applied to the top.

### Conclusion

The solutions developed for renovating the Galecopper Bridge were unusual because of the nature of the problems and the very limited space and time in which the engineering team had to work. Bridge closure was not an option so the work had to be done while the daily business of Utrecht continued around it.

Teamwork was vital. All the knowledge and expertise necessary to arrive at the best solution were brought together in the team, and decisions were supported by all parties. Building good relationships with the many stakeholders living, working and doing business around the bridge was important and the team did this very successfully.

Rijkswaterstaat, Arup and RoyalHaskoningDHV and the Galecom consortium collaborated extremely well to bring the project to a successful conclusion and are sharing their findings with



governments, designers, engineers and contractors facing similar issues in other parts of the world. Lessons learned will also be used in reinforcing the other bridges in the Netherlands which require renovation.

**Authors:**

*Sander den Blanken* is a civil engineer and Group Leader of Arup in the Netherlands. On this project, he fulfilled the delegated client position as Project Manager RWS of the Galecopperbrug, and Arup's JV Managing Contractor board representative.

*Frank van Berge-Henegouwen* is a civil and structural engineer in the Amsterdam office. He advised on matters relating to the foundation of the bridge and the HSC overlay.

*Pat Moore* is a civil engineer in the Dublin office and was Chief Structural Designer for the substructure of the bridge.

*Daan Tjepkema* is a bridge engineer in the Amsterdam office and was Chief Structural Designer of the superstructure of the bridge.

*Dimitri Tuinstra* is Senior Bridges Engineer in the Amsterdam office. He was Technical Manager of the project and is currently overall Technical Manager of the MC.

**Project credits:**

Client: *Dutch highways authority ('Rijkswaterstaat')*  
 Construction and process management: *RoyalHaskoningDHV*  
 Preparation and construction: *Contractor combination Galecom (KWS Infra B.V., Mercon Steel Structures and Hollandia B.V.)* with partner for the jacking: *CT de Boer*  
 Project management, bridge design, civil engineering, geotechnics and structural design: *Arup – Fergus Aitchison, David Ashurst, Lukasz Bies, Beatriz Blanco, Sander Boogers, Jan Willem Breider, Luke Brotherton, R Campo, Simon Cardwell, Harry Clements, Marijke Coenders, Steven Cook, W Cruz, Artur Czarnecki, Ian Davis, Simon Dean, Rob De Bruijn, Artur Ruiz De Villa Valdez, Sander Den Blanken, Eleni Drogari, Julia Farre, Martin Flint, Graham Gedge, Rupert Gibson, Elena Gogou, David Gratton, John Haygarth, Tim Hocombe, Richard Hornby, Demis Karagiannis, Tom Kau, Sachin Kumar, Wai Kwok Lam, Conor Lavery, Rob Livesey, Cristina Lundmark, Giorgio Mediati, E Mijares, Pat Moore, Chris Murgatroyd, Silas Norager, Jeroen Oskam, Giuseppe Pelagalli, Ouiam Rhersella, Richard Robben, Laurent Rus, Mark Sanders, Vivian Scheepers, Daneil Sequiera De Gois Neto, Giuseppe Simonelli, Pascal Steenbakkers, Julia Summers, Tim Taylor, Edwin Thie, Daan Tjepkema, Roland Trim, Mia Tsiamis, Dimitri Tuinstra, Frank Van Bergehenehouwen, Wesley Van Der Bent, P Van Zantvliet, Roel Vernooij, Alessandra Villa, Adam Vojtek,*

*Edo Vonk, Mira Wingelaar, Ying Zhou.* The authors also wish to thank *Harold Hansen* for assisting in the preparation of this article.

**Image credits**

1 and 2: *Snowwhite* commissioned by *Rijkswaterstaat*; 3, 9, 10, 11, 12, 14 *Ton Borsboom Fotografie*; 4, 5, 6, 7, 13 *Arup*; 8 *Rijkswaterstaat*; 15 *Bas Stoffelsen*.

15. Galecopper Bridge at night

## About Arup

Arup is a global organisation of designers, engineers, planners and business consultants, founded in 1946 by Sir Ove Arup (1895–1988). It has a constantly evolving skills base, and works with local and international clients around the world.

Arup is owned by Trusts established for the benefit of its staff and for charitable purposes, with no external shareholders. This ownership structure, together with the core values set down by Sir Ove Arup, are fundamental to the way the firm is organised and operates.

Independence enables Arup to:

- shape its own direction and take a long-term view, unhampered by short-term pressures from external shareholders
- distribute its profits through reinvestment in learning, research and development to staff through a global profit-sharing scheme, and by donation to charitable organisations.

Arup's core values drive a strong culture of sharing and collaboration.

All this results in:

- a dynamic working environment that inspires creativity and innovation
- a commitment to the environment and the communities where we work that defines our approach to work, to clients and collaborators, and to our own members
- robust professional and personal networks that are reinforced by positive policies on equality, fairness, staff mobility and knowledge sharing
- the ability to grow organically by attracting and retaining the best and brightest individuals from around the world – and from a broad range of cultures – who share those core values and beliefs in social usefulness, sustainable development and excellence in the quality of our work.

With this combination of global reach and a collaborative approach that is values-driven, Arup is uniquely positioned to fulfil its aim to shape a better world.

Printed by Pureprint Group using their *pureprint*® environmental print technology. The printing inks are made from vegetable based oils and no harmful industrial alcohol is used in the printing process with 98% of any dry waste associated with this production diverted from landfill. Pureprint Group is a CarbonNeutral® company and is certificated to Environmental Management System *ISO 14001* and registered to EMAS, the Eco Management and Audit Scheme.

The Arup Journal  
Vol150 No2 (2/2015)  
Editor: Angela Swann  
Designer: Martin Hall  
Editorial: Tel: +44 (0)20 7755 4838  
email: arup.journal@arup.com

Published by Global Marketing and Communications,  
Arup, 13 Fitzroy Street,  
London W1T 4BQ, UK.  
Tel: +44 (0)20 7636 1531  
Fax: +44 (0)20 7580 3924

All articles ©Arup 2015