

THE ARUP JOURNAL

Vol. 17 No. 1 April 1982
Published by
Ove Arup Partnership
13 Fitzroy Street, London W1P 6BQ

Editor: Peter Hoggett
Art Editor: Desmond Wyeth FSIAD
Assistant Editor: David Brown

The Arup Partnership
Geotechnics Seminar 1981

Contents

Introduction by M. Stroud	2
Local reports	
Geotechnical problems of Chater Station, Hong Kong, by R. Davies and D. Henkel	4
Windblown sand along the Jeddah/ Riyadh/Dammam Expressway, by J. Redding and A. Lord	11
Local settlement of debris treated by vibro-replacement, by W. Wrigley	16
The design of sheet pile walls, by D. Henkel	22
Aerial photography and satellite imagery and route selection, by J. Henry	24
Construction of embankments on soft clays, by J. Davies and P. Dauncey	27

Front cover: Sheet piling and ground anchors: London-Birmingham Railway 1830 (Photos: Ove Arup & Partners)

Back cover: Satellite image of the Earth from space (Photo: Copyright University of Dundee)

The Arup Partnership Geotechnics Seminar 1981

Introduction

Martyn Stroud

For two and half days in June 1981 representatives of Arup offices around the world met in London to discuss geotechnics. The seminar, one of a series promoted by the Arup Partnership to foster personal contact between the firm's widely dispersed groups, brought together geotechnical specialists and non-specialist project engineers alike.

Keynote address

At an opening dinner at the Danish Club on the evening before the seminar, Peter Dunican welcomed the participants and invited David Henkel to introduce the proceedings. David began 'Too often we meet to discuss geotechnical problems in conditions where instant answers are needed. Over the next few days we will be able to meet without this pressure and we must take advantage of it to have real discussion and exchange points of view.

Over the last 10 years we have seen our geotechnical skills tested in environments outside our well-ordered world of Western European geology and soil mechanics, and we have had to face a whole new sense of problems which occur in tropical and sub-tropical climates, as well as in the conditions, of much of the Middle East. We have had to learn fast and have also made mistakes in the unfamiliar world of tropical weathering, the formation and the solution of evaporates. The presence of our colleagues from Australia, Hong Kong, Papua New Guinea, and South Africa, where problems of unsaturated ground and weathering play a major part, is particularly gratifying.

If we need a Keynote for this seminar, I think that it should be a resolve to develop 2 very much closer working relationships

between the geotechnical engineer and the project engineer and/or job team.

An attitude sometimes surfaces that geotechnics is something special and apart. The word "Mafia" has been used from time to time.

The separation of geotechnical input from the whole of the design and construction process can be very dangerous. I hear sometimes of attitudes of "them and us" developing, e.g. "They don't tell us what is going on", etc.

I am therefore glad to see many non-geotechnical engineers here and I hope that the ideas and views generated in the next few days will ensure that we achieve a fuller integration of geotechnical skills with both our local and overseas operations.

Initially I want to emphasize again that in spite of all our analytical and computational skills the reality is on the site in the ground. We still do not observe properly what goes on at the site and measure enough movements, water levels, etc. Better field observations and recordings are essential to our progress and I should like to see this recognized *explicitly* at the start of a job and the costs allowed for.

The extensive field observations made during the construction of Chater Station in Hong Kong have made it possible for us to design with confidence the basement of the Hong Kong and Shanghai Bank and other deep basements.

One of our goals must be to improve on our field observations and put them into forms which are readily accessible. Some of our records are on the papers you have been given, but more remain to be done.'

The Seminar

The breadth of activity in ground engineering within the firm was well represented in papers presented to the seminar and in the discussions which followed. Topics ranged from philosophical consideration of 'The role of geology in engineering' to the very specific 'Design of sheet pile walls'. Many of the papers reflected considerable advances in the 'state of the art' made over the past five years or so in the course of tackling Arup jobs, particularly in the fields of ground improvement and diaphragm wall design. A selection of these papers is reproduced in this

volume. Other papers reflected some of the problems uppermost in our thinking at present where challenging frontiers continue to be advanced.

One session, for example, considered the current debate on the applicability of limit state design to geotechnical engineering and its compatibility with structural engineering design. Another was devoted to the design of industrial floor slabs, a topic which led to much interesting discussion and one for which the design rationale is perhaps least clear. It was agreed that a combined geotechnics/building engineering working party should be set up to draw together the firm's experience in floor slab design and to establish a methodology for future design.

But perhaps one of the most fascinating sessions was the first in which representatives from geotechnical groups throughout the Arup domain talked briefly about their own experiences in geotechnical engineering. This session served to illustrate the great variety in technical problems tackled, from low cost road projects in developing countries to deep basements in the hearts of major cities, and moreover illustrated the different ways in which geotechnical advice is provided throughout the firm. Whereas some of the Partnership have well-established in-house geotechnical groups, both providing a service to other parts of the firm and taking on direct commissions, others rely on specialist outside consultants or geotechnical groups in other parts of the firm for advice. It is worth summarizing briefly these local reports presented at the seminar.

Local reports

Australia: introduced by Ken Gilbert

The Australian practice has built its reputation on large multi-storey buildings in the state capitals of Sydney, Perth and Melbourne but current efforts to move into the industrial and heavy civil engineering field are proving successful. Geotechnical advice has, until now, been obtained from outside the firm with the consultancy being let on a competitive basis and the advice, although sound and reliable, was sometimes felt to be conservative.

Tony Phillips has recently joined the Australian Partnership to set up a geotechnics group and this will allow geotechnics to become an integral part of the design process rather than just a preliminary stage. It is believed that Arups are the first structural firm in Australia to have such an in-house geotechnics capability. However, a handicap for Tony at the moment is the large distances between sites and the enormous amount of travelling necessary.

**Papua New Guinea:
introduced by Clive Humphries**

Our work in Papua New Guinea, which comes under the auspices of Arup Australia International, is more or less equally divided between structural and civil projects. Most structural projects were, until recently, low rise buildings but two current jobs are 12 storeys. The civil projects include roads, bridges, public health and marine works.

The country presents a wide range of problems for the engineer. The difficult terrain, with the central highlands rising to 3,500 m, a poor road system and dense jungle provide access problems, the equatorial climate with annual rainfall of 4,500 mm on the west coast leads to groundwater and drainage problems and has promoted extensive weathering of the rocks, and the country is located in a zone of very high seismic activity.

Geotechnical advice is normally obtained from the Government Geological Survey or the island's sole specialist consultant. As many of the projects are small in scale the cost of seeking advice from outside the country cannot usually be justified but it is hoped that Tony Phillips in Australia might be able to give advice in the future.

**Hong Kong:
introduced by Andrew Chan**

Very rapid growth in the geotechnics group, from 6 to 27 in only two years, has largely resulted from the introduction of a statutory checking system, unique to Hong Kong, requiring the engagement of geotechnical specialists for all developments. Hong Kong now has the highest ratio of geotechnical to structural engineers anywhere in the world and the checking system has a major influence on the approach adopted to geotechnical problems.

As well as servicing Building Engineering groups in Hong Kong (30% workload) the group undertakes direct commissions (70% workload) which have included area studies of slope stability, consultancy to the architect's office of the Public Works Department and site formation/slope stabilization work for private developers.

There is often pressure from clients to adopt designs that will be approved by the Government Geotechnical Control Office with the minimum of expense and delay and this can lead to conservative design. Andrew felt there must be a greater willingness to argue with the checking authority, as the potential cost savings for the client are much greater than any likely increase in our fees. It should also be possible in future to incorporate the results of recent research into slopes with suction and partially saturated soils. These are problems common to Hong Kong but not always well understood.

**Middle East:
introduced by Andrew Lord**

Much of our work in the Middle East is through commissions from UK architects with the structural design being carried out by the Building Engineering groups in London. Largely as a result of this, geotechnical work in the Middle East has been serviced from London with site investigations supervised by engineers from London,

Carbonate rocks and soils derived from them predominate in the Arabian Peninsula and suffer from the basic problems of limestones with a risk of solution cavities and a shortage of good hard aggregates. Also the solution of gypsum and anhydrite layers interbedded with the limestones can lead to collapse and brecciation of the limestone and high soil and groundwater sulphate concentrations.

Windblown sand presents another major problem and we have carried out some original work on this for the SAR-A road project.

**South Africa:
introduced by Graham Plant**

Most of the jobs of the eight strong geotechnics group based in Johannesburg (with one member permanently in Durban) are in the Transvaal but the group also services offices in Pretoria, Cape Town, Windhoek, Gaborone and Mauritius. In addition to service work (50% workload), the group undertakes direct commissions covering planning studies, geotechnical mapping, insurance investigations, tailings disposal, reservoirs and slope stability. An in-house soil testing laboratory is also based in Johannesburg but all drilling is carried out by specialist contractors.

A problem commonly encountered within South Africa is that of collapsing and expansive soils and special techniques for dealing with them have been evolved by the group. Outside advice is obtained almost exclusively from David Henkel but recently expert advice has been sought from Victor de Mello of Brazil for the Guibies Dam investigation in Mauritius.

Graham felt it was important that more effort was put into marketing of the geotechnical expertise within Arups. With stiffer competition expected in future, aggressive marketing will be required just to maintain our market share, whereas the aim is to grow. This could take the form of lectures, papers, presentations, brochures and open evenings.

**Ireland:
introduced by Peter Langford**

Although the Irish practice established itself with structural work for architects, it has recently been very successful in the field of civil engineering, major jobs being the reconstruction of Cork Quay Walls, the design of Waterford Airport, the design of road embankments on soft clays of Athlone and Galway and the investigation for a gas pipeline between Cork and Dublin. At present there is no geotechnical specialist in Ireland and advice is obtained from London.

Peter considered it very important that the Project Director had sufficient knowledge of geotechnics to understand the problems and be able to control the job on the basis of advice from the specialist. A 'black box' approach with engineers blindly acting on advice from specialists could be dangerous. Education is important and, ideally, advantage should be taken of experience gained on each project to develop a local expertise.

**Scotland:
introduced by Howard Roscoe**

The four-man geotechnics group is part of the special projects group based in Edinburgh and, as well as servicing the offices in Edinburgh, Glasgow, Dundee and Aberdeen, undertakes direct commissions.

Much of the economic activity of the area is concentrated in the central lowlands and, as much of this area has been undermined, geotechnical investigations frequently include the assessment of the stability of old workings.

A problem common to small jobs is that it is often difficult to justify full-time supervision of small investigations on cost grounds, but

the quality of the work carried out by local contractors usually makes this necessary.

Howard also drew attention to the advantages and disadvantages of geotechnics operating as a central group, physically remote from the project teams. Although the group's involvement in the early stages of projects is well-defined it was felt that there was a need to develop better links in the later stages.

**Wales & West:
introduced by Gabe Treharne**

Although initially serviced from London, a geotechnics group was set up which has subsequently grown alongside civil engineering. This has given the advantage of civil engineers being more aware of geotechnical problems and geotechnical engineers being more aware of contractual matters. Servicing the structural groups now forms only 10% of the workload, 60% being direct commissions and 30% desk studies for possible jobs.

A feature of the growth of geotechnics in Wales and West has been a good relationship with London and interchange of personnel to match peaks and troughs in the workload which has been of mutual benefit to both groups.

**Birmingham:
introduced by Alan Turner**

A geotechnics group has recently been established to service the Birmingham office and take on direct commissions. The main problems in the Midlands are associated with past industrial activity, parts of the area being underlain by old coal and limestone workings.

Unhappily, many local developers prefer to pay a small fee to local mining consultants for a qualified opinion on ground conditions than pay for a proper site investigation and its interpretation. However a notable success for the group has been a recent major commission to investigate the stability of the old limestone workings.

**London:
introduced by Martyn Stroud**

The geotechnics group in London, which is part of Civil Engineering Division, is between 30 and 40 strong and provides a service to the Building Engineering groups in London, Arup Associates and regional and overseas offices. It also provides assistance with civil engineering projects and takes on commissions from outside clients. As the group has grown it has become much more international in its outlook.

The services work continues to include a wide range of interesting problems with recent jobs including deep basements in London and Cairo (where there are difficult dewatering problems) and an investigation in the North Sea from a jack-up for a Post Office transmission tower. Within Civil Engineering, geotechnics has been involved with several large projects including the Nigerian Railway, SAR-A, Hong Kong Metro and urban roads in Benghazi.

Geotechnics' own commissions are obtained from a broad front of clients and cover a pleasing diversity of problems, there having been a trend over the last five years to obtain more work with a contractor as client. Recent work carried out on limit state design methods for Building Research Establishment has resulted in an invitation to Brian Simpson to sit on the European Code Drafting Committee.

Martyn felt that relationships with job staff are usually very good and emphasized the importance of continued close cooperation between the various geotechnical groups. He also agreed that further education, both amongst structural engineers and within geotechnics, would be beneficial.

Geotechnical problems associated with the construction of Chater Station, Hong Kong

Richard Davies
David Henkel

Introduction

The construction of Chater Station involved a deep excavation in a congested urban area. This presented major problems in both engineering and planning as it was necessary to ensure minimal disturbance to the surrounding area and to maintain traffic flow and services. Ground movements around the excavation were also of the utmost importance as the consequences of damage to adjacent building would be high and would incur substantial costs and delays.

The problem of predicting ground movements was, however, complex as it involved the inter-relation of many factors including ground conditions, methods of construction and groundwater control. Furthermore, the situation could be greatly influenced by factors which were difficult to assess, such as workmanship and geological and constructional details, and this placed severe limitations on the validity of predictions based on soil tests and theoretical analysis alone. Thus, during construction the performance of the excavation was under constant review and changes were made to the construction techniques as the actual behaviour of the excavation and surrounding ground became better understood.

The contract

Chater Station formed part of Contract 106 of the Hong Kong Mass Transit Railway. The contract was awarded in early 1976 to the Metro Joint Venture, comprising Dragages DTP (Sponsor), Hochtief AG., Gammon (HK) Ltd. and Sentab. In March 1976 Ove Arup and Partners were commissioned by the Joint Venture to carry out the design of the station and to provide geotechnical advice on matters arising from its construction. The

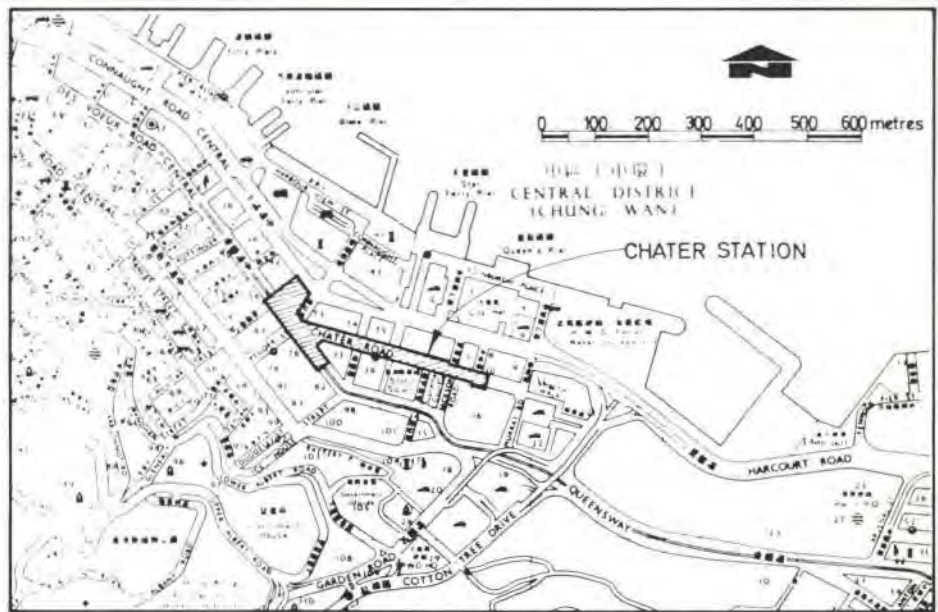
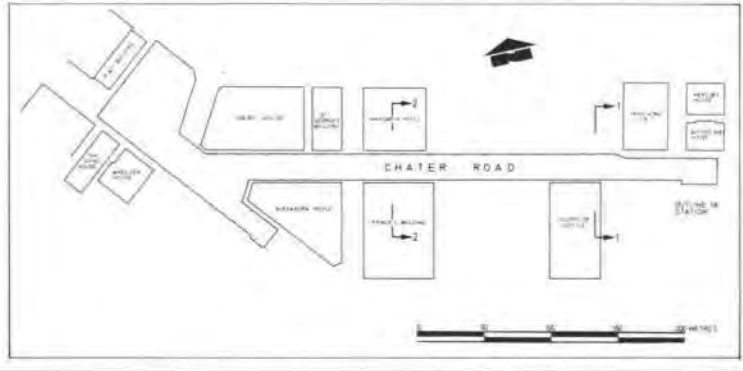

Fig. 1 Site location

Fig. 2 Plan of Chater Station and adjacent buildings



diaphragm wall described in this paper was constructed by the Bachy Soletanche Group. Main construction commenced in October 1976 and the station was handed over to the Mass Transit Railway Corporation in February 1980.

Chater Station

The station is situated in the heart of the commercial district of Hong Kong in an area of reclaimed land (Fig. 1). Historically, this

area has always been the focus point of Hong Kong and is the site of important old colonial buildings as well as prestigious high rise blocks. At the site the water table is high and the ground conditions poor, with loose reclamation fill and marine deposits over a residual soil derived from the decomposition of granite. The latter material is basically a silty sand and has been described in detail by Lumb¹.

The station is shown in plan in Fig. 2 and in

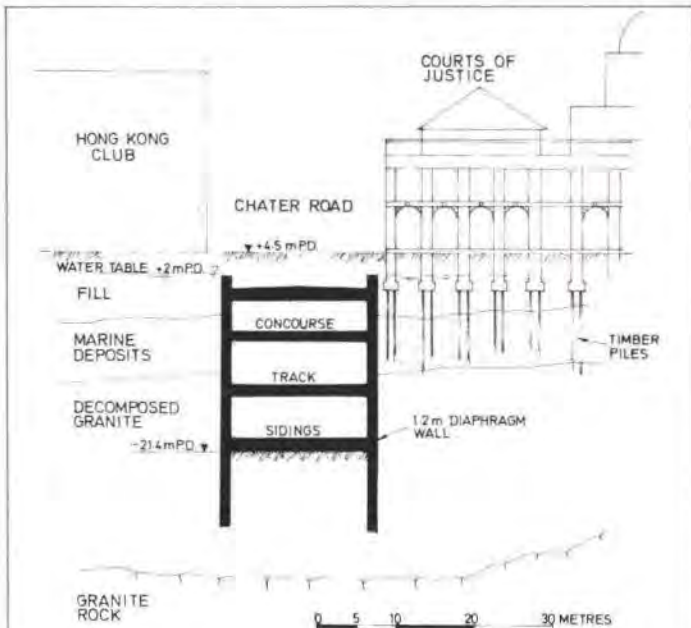

Fig. 3 Section 1-1

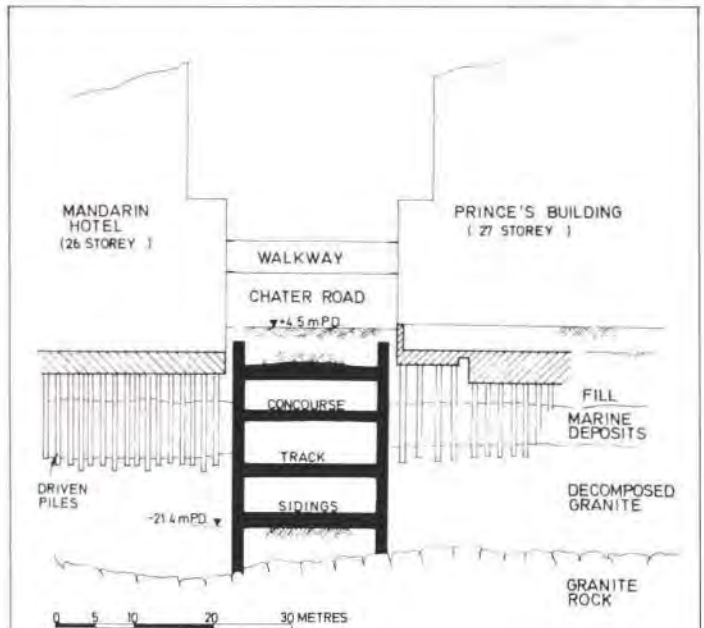

Fig. 4 Section 2-2



5



7

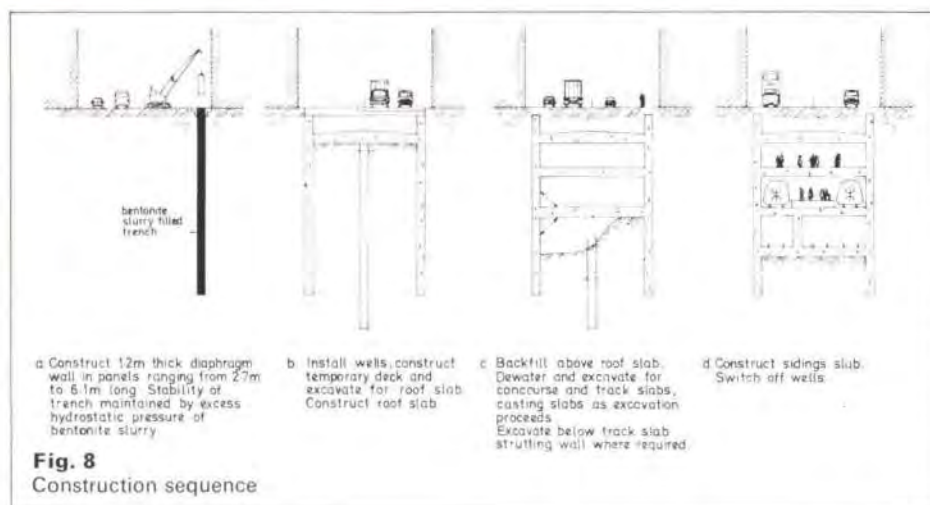

Fig. 8
Construction sequence

section in Figs. 3 and 4. The station comprises three levels which form the concourse, track and sidings levels. Construction involved an excavation up to 27 m deep and approximately 400 m long which took up almost the entire length and width of Chater Road (Fig. 5). At the eastern end, the excavation came within a few metres of the older buildings such as the Courts of Justice (Fig. 6) and even closer to the high rise blocks to the west (Fig. 7).

The sequence of construction is shown in Fig. 8. A diaphragm wall was constructed around the perimeter of the station before the main excavation commenced, the station roof and floors being cast as excavation proceeded. The diaphragm wall formed both temporary support to the excavation and the permanent wall for the station. During construction the excavation was kept dry by pumping from a series of deep wells installed along the centre line of the excavation.



6

Fig. 5
General view of Chater Road during station construction

Fig. 6
The Courts of Justice

Fig. 7
The Mandarin Hotel and Princes Building

Preliminary assessment of construction method

In view of the proximity of adjacent buildings the need to control both ground movements and the stability of the excavation was of major importance, although quantifying the problem was difficult. Prior to construction of the Hong Kong Mass Transit System very little was known about actual movements around deep excavations in these geological conditions and virtually no data existed on the behaviour of decomposed granite under conditions of stress relief. The construction method was, however, one of the most positive and stiffest methods available and had been successfully used for the construction of deep basements and subway systems in Europe and the United States where control of ground movements was important. Even so, movements of the ground surrounding the excavation were to be expected as a result of the diaphragm wall construction, dewatering and excavation.

(a) Diaphragm wall construction

Construction of the diaphragm wall involved excavating and concreting a series of panels between 2.7 and 6.1 m long up to 37 m deep adjacent to existing building foundations. Experience elsewhere suggested that the main problem would be ensuring stability of the trench and, provided this was satisfied, settlements would be small.

During excavation, the trench is supported by bentonite slurry which normally has a specific gravity only slightly greater than water. For stability of the trench in a soil such as a silty sand where negative pore pressures dissipate during the period of excavation, the earth pressure and horizontal pressure due to surcharge have to be supported by the effective slurry pressure (i.e. the difference between the slurry pressure inside the trench and the external static water pressure). Thus, in situations such as Chater Road where the water table is high, the elevation of the slurry head above the water table is a critical factor and stability is highly sensitive to small changes in slurry head.

The problem is illustrated in Fig. 9. In the example, the earth pressure and horizontal surcharge pressure have been calculated using arching theory. In plan, it is assumed that the soil forms a semi-circular arch around the trench and, with depth, the horizontal pressure is reduced by vertical arching in a similar manner to silo theory (Fig. 10).

A theoretical study was carried out to examine the problem in detail for each of the buildings. For the majority of the high rise buildings it was possible to show that, whilst

the surcharge pressure could not be supported by the effective slurry pressure, the structure and foundation of the buildings could redistribute the load. For the older buildings such as the Courts of Justice and the Hong Kong Club the problem was less severe since the surcharge loading was considerably less. Thus, in the majority of cases, provided the bentonite level was kept high and the panel length relatively short, construction using conventional methods was possible.

This was not the case, however, for construction of the wall adjacent to Swire House at the western end of Chater Road. This building is 22 storeys high and is founded on small individual pile caps beneath each column with piles driven just to the top of the decomposed granite. The superstructure is also relatively flexible and it was clear that either the building had to be underpinned to rock or major changes would have to be made to the construction method.

To gain better understanding of the behaviour of the ground adjacent to a diaphragm wall excavation, an instrumented test panel excavation was carried out. The details of the test and results are described by Stroud and Sweeny². The test generally confirmed that, except for Swire House, stability of the trench could be maintained, provided careful control was exercised during construction.

(b) Dewatering

Settlement due to dewatering occurs as a result of an increase in effective stress in the ground. To quantify the problem it is necessary to know the drawdown/depth profile outside the excavation and the compressibility of the soil.

Although reasonable estimates of the compressibility of the soil can be made from in situ penetration tests, laboratory tests, and experience with foundation settlements, estimating the drawdown/depth profile is rather more difficult. Much depends on the local permeability profile and geological variations and, where rock is high, the detailed connection between the base of the diaphragm wall and rock. The latter consideration was of particular concern at Chater Road since the rock level varied substantially over very short distances and it was doubtful if a satisfactory cut-off could be achieved.

To attempt to quantify drawdown, a series of parametric studies were carried out using a finite element seepage programme assuming various conditions of permeability profile and cut-off. Some data was available from bore-hole tests on relative permeability but the test results were difficult to rely on with confidence. Some of the results of these studies are shown in Fig. 12. The study clearly indicated that wide variations in drawdown could occur and if unfavourable situations arose, dewatering settlements, particularly of the older buildings, could be excessive.

Estimating the possible dewatering settlement of the piled buildings presented a special problem. Settlement of the ground relative to the pile causes negative skin friction which can increase the load on the pile. The latter factor is important for end-bearing piles when the penetration into the bearing strata is small and, in these circumstances, it is possible for piled buildings to settle almost as much as the ground surface. Large settlements due to dewatering where pile penetration into the bearing strata was small, have for example, been observed by Lumb³ in the Mongkok area of Hong Kong.

To illustrate the problem for the buildings at the west end of Chater Road, the preliminary estimates of settlement due to dewatering are shown in Fig. 11.

(c) Excavation

Movements of the ground around the station were anticipated as a result of vertical and

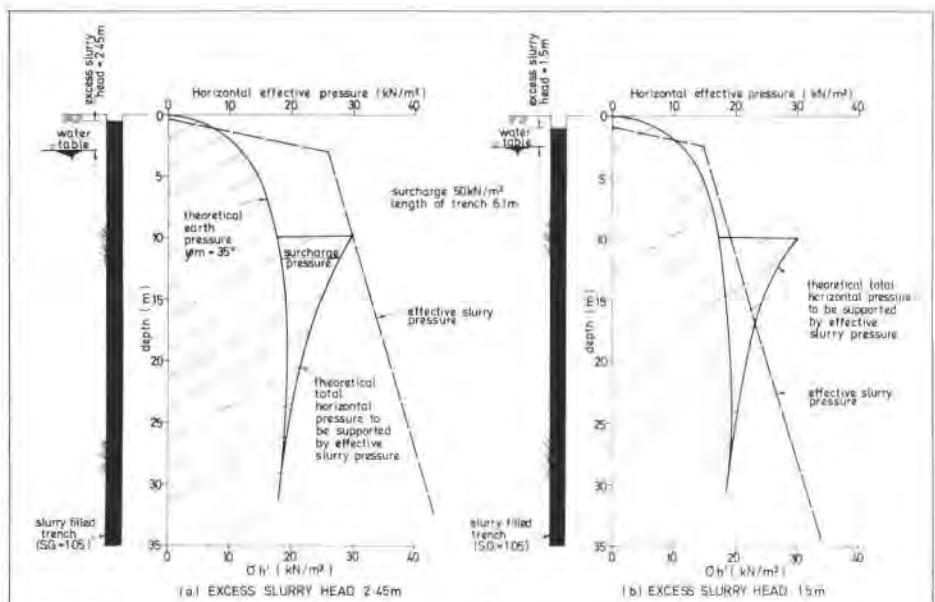

Fig. 9 Stability considerations for diaphragm wall excavation

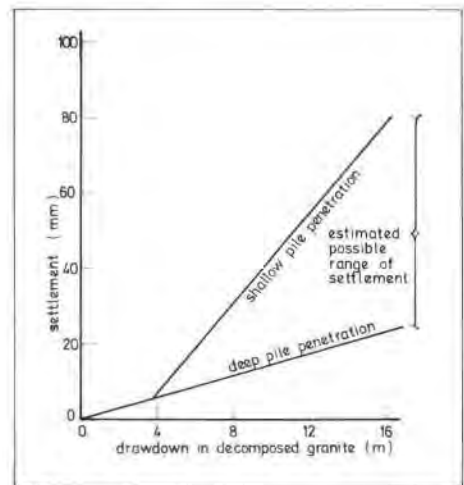
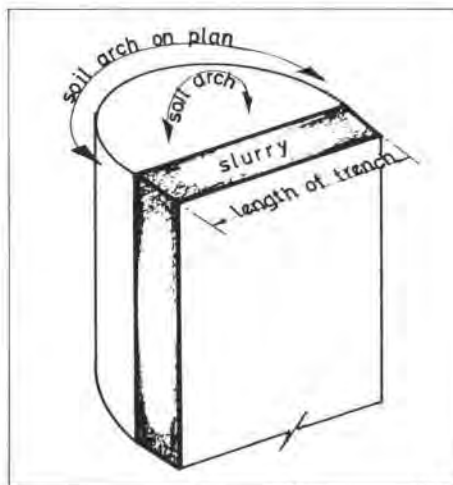
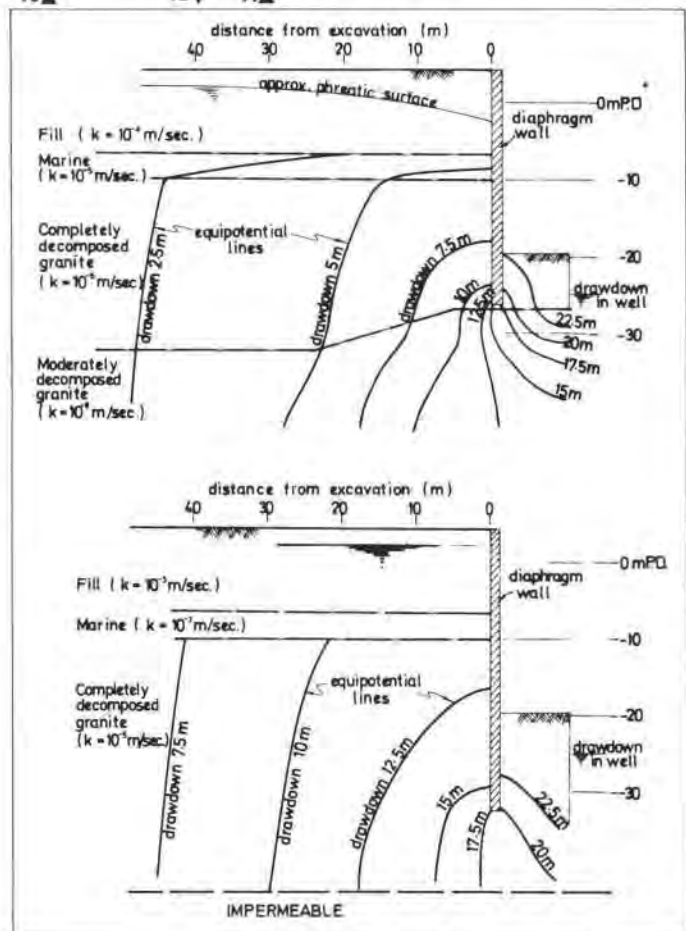

Fig. 10 Model of soil arching for preliminary assessment of earth pressures around slurry trench

Fig. 11 Preliminary estimate of settlement of piled building due to dewatering

Fig. 12 Some results of parametric study of dewatering problem



horizontal stress relief due to excavation. The amount and mode of movement depends to a large degree on the deflection and stiffness of the wall and support system (Fig. 13).

A review of available data, concerning the movements around similar well-supported excavations elsewhere in the world where stiff diaphragm walls have been used, suggested that lateral movements and settlements of the ground were likely to be of similar magnitudes with maximum movements of about 0.15 to 0.2% of the depth of excavation. This represented movements of around 40 to 50 mm. Also, movements could be expected to occur at least to a distance away from the excavation equal to its depth.

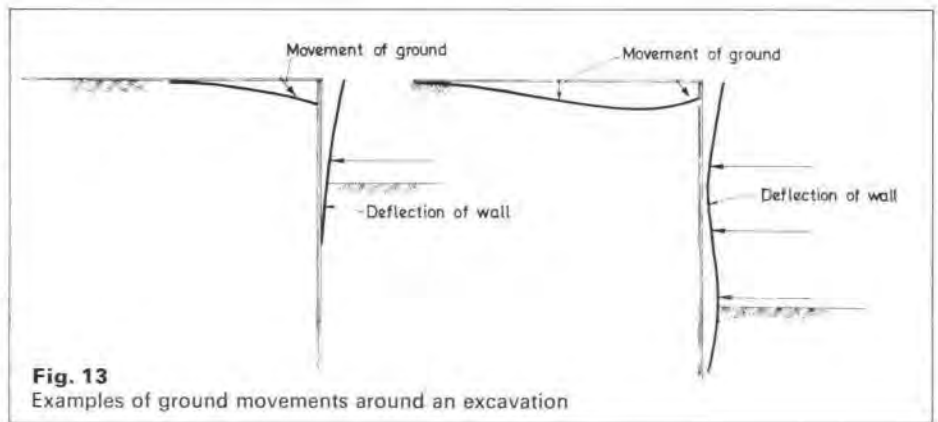

Fig. 13
Examples of ground movements around an excavation

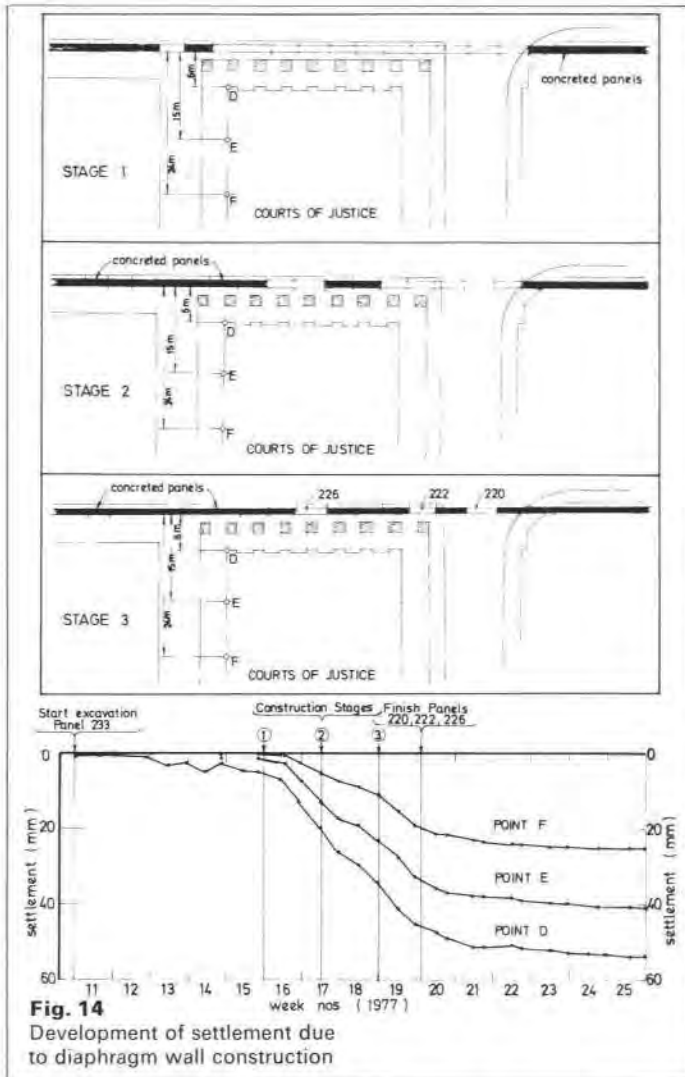

Fig. 14
Development of settlement due to diaphragm wall construction

A theoretical study of the problem was also carried out by modelling the stiffness of the wall and support system with assumed earth pressure coefficients and soil stiffness. This gave similar results for the magnitude of deflection of the wall although little was known about the actual in situ properties of the soil.

From the preliminary assessment of the stability of the excavation and possible ground movements it was clear that many problems had to be resolved, some of which could only be tackled during construction after initial measurements of the actual behaviour of the ground became available. Also, the construction period was extremely short and there was little time to carry out extensive field and laboratory tests to supplement the tender information. A programme of instrumentation was therefore devised to monitor settlements of buildings, horizontal ground movements and changes in pore pressure and, if necessary, measures could be taken to overcome the problems during construction.

Monitoring

Throughout the period of construction, the settlement of all buildings was measured at least once a week and, during critical periods, up to twice a day. Piezometers were installed at various depths adjacent to all the buildings. Inclinometers to measure horizontal movements were also installed adjacent to the Courts of Justice at the eastern end of the station and adjacent to Swire House to the west.

Construction of the diaphragm wall

Construction of the diaphragm wall commenced in October 1976 and by March 1977 approximately half of the northern wall had been completed. This was followed by construction of the wall adjacent to Princess Building and the Courts of Justice on the southern side of the station.

During construction of the diaphragm wall relatively large settlements of the buildings occurred, with maximum settlements of 38 mm at the Hong Kong Club, 78 mm at the

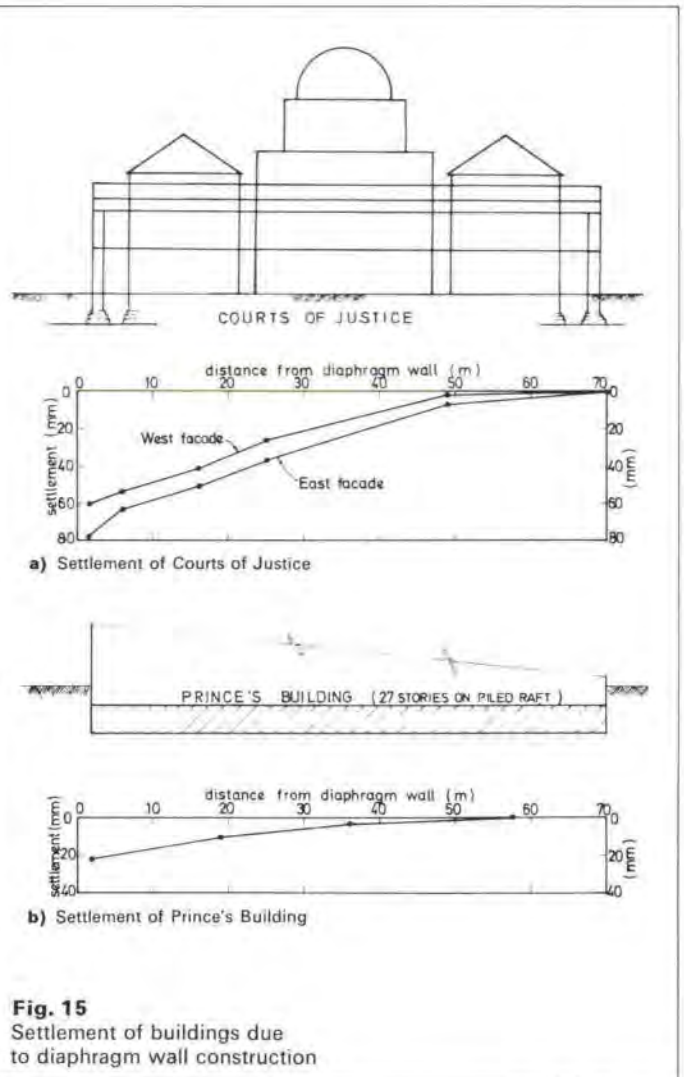

Fig. 15
Settlement of buildings due to diaphragm wall construction

Courts of Justice and 21 mm at Princes Building. The magnitude of settlement was considerably larger than anticipated and, as far as the authors are aware, very much greater than has been reported elsewhere in the world as a result of diaphragm wall construction. The development of settlement was also unusual. Most of the settlement did not occur during excavation of a single panel as might be expected if problems of instability were arising but, as shown in Fig. 14, occurred during the construction of a series of adjacent panels. By the time the wall was completed settlements were observed up to 50 m away from the wall (Fig. 15).

It was also observed that construction of the north wall had resulted in a rise in the water table which would have reduced the effective slurry pressure supporting the subsequent south wall excavations. The magnitude of the observed settlements showed a marked similarity to the local horizontal movements in the decomposed granite measured in the test panel excavation and was dependent on 7

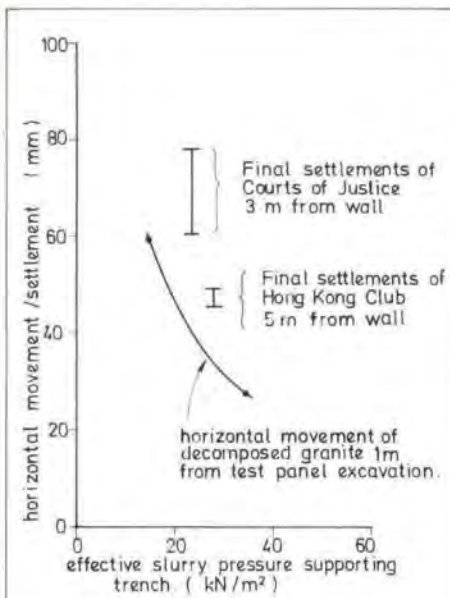

Fig. 16
Horizontal movements and settlements associated with diaphragm wall construction

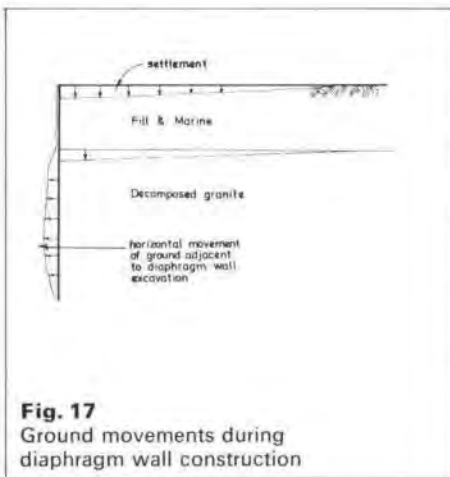

Fig. 17
Ground movements during diaphragm wall construction

the effective slurry pressure supporting the individual excavations (Fig. 16). This suggested that the final settlement was controlled by horizontal movements in the decomposed granite during excavation of individual panels. From the evidence of the data from the test panel excavation and laboratory tests, it is believed that the horizontal movement adjacent to individual panels was a result of swelling of the decomposed granite which created a compressible zone around the diaphragm wall panel. On construction of adjacent panels, the arching around the compressible zone broke down and recompression occurred as the earth pressure built up. This caused horizontal ground movements to extend back from the diaphragm wall, which resulted in the large settlements (Fig. 17).

The occurrence of large settlements during the early stages of construction had an important influence on the method of constructing the diaphragm wall adjacent to Swire House. As previously stated, this building was founded on individual pile caps and it was doubtful that the combined structure and foundation could redistribute load during the excavation stage. The option to underpin the foundations adjacent to the wall was reconsidered. However, since experience had shown that settlements extended a considerable distance from the wall, it would have been necessary to underpin the entire building, which was considered impractical. It was therefore decided to control the stability of the trench and limit settlement by constructing the diaphragm wall in short lengths (Fig. 18) and to increase the effective slurry pressure to about 100 kN/m². This was achieved by reducing the water level in the decomposed granite by about 6 m using wellpoints (Fig. 19), increasing the density of the slurry and raising the slurry level above ground level using a high guide wall (Fig. 20).

The construction of the diaphragm wall adjacent to Swire House is shown in Fig. 21. Throughout construction, horizontal deformations of the ground were measured using inclinometers and the settlement of each column was measured daily. The maximum

horizontal ground movement recorded was about 14 mm which occurred just below the toe of the piles (Fig. 19). The maximum settlement of the building was about 30 mm of which about half was due to the well-point dewatering.

Dewatering

Following completion of the diaphragm wall, the main dewatering wells were installed at about 15 m spacing along the centre line of the station. To examine the efficiency of the wells and drawdown outside the excavation, a series of pumping tests were carried out. The tests showed that marked variations in drawdown occurred outside the excavation depending on the local geology and details of the diaphragm wall construction.

It was therefore decided to proceed with the initial stages of dewatering for the construction of the roof slab by drawing down the water level in all of the wells by 9 m to about -7 m P.D. This would provide a full-scale test and the corresponding drawdown and settlement pattern for each individual building could then be considered.

The results of the initial stage of dewatering and corresponding settlements at the Hong Kong Club and Courts of Justice at the eastern end of the stations are shown in Fig. 22. At the western end of the site, the situation was rather more complex. Dewatering was being carried out in the area for caisson construction unconnected with construction of the station, and the drawdown outside the excavation was rather more than that due to station construction alone. However, from the piezometric and settlement data the drawdown in the decomposed granite could be related to the settlement of the piled buildings as shown in Fig. 23.

From the information collected during the initial stages of dewatering it was possible to predict dewatering settlements with reasonable accuracy and it became clear that the main problem would be settlement of the older buildings at the eastern end of the station where dewatering settlements of about 80 mm could be expected by the time the station was complete.

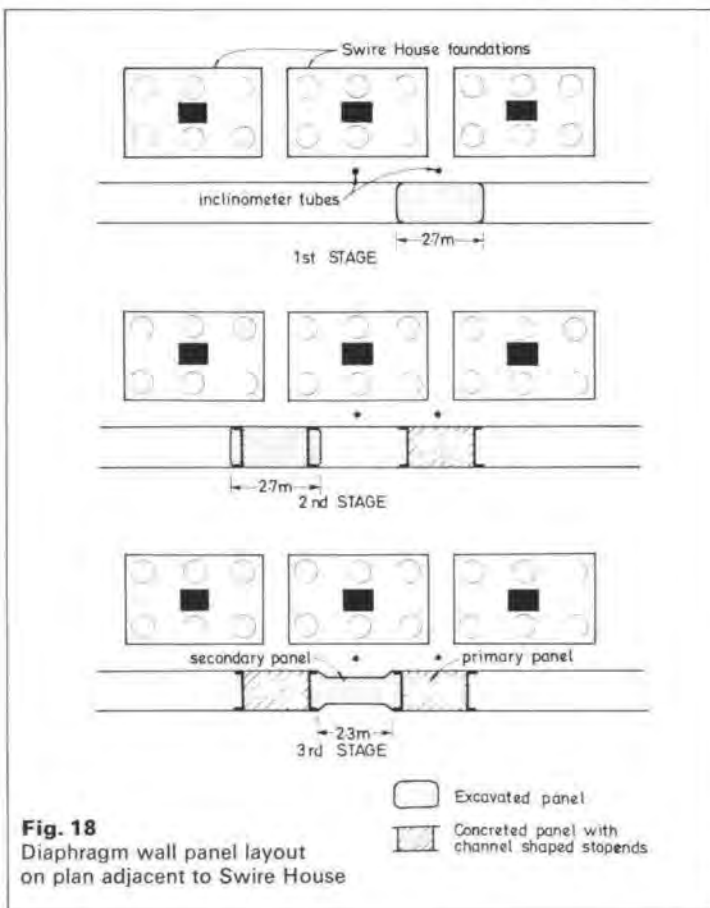

Fig. 18
Diaphragm wall panel layout on plan adjacent to Swire House

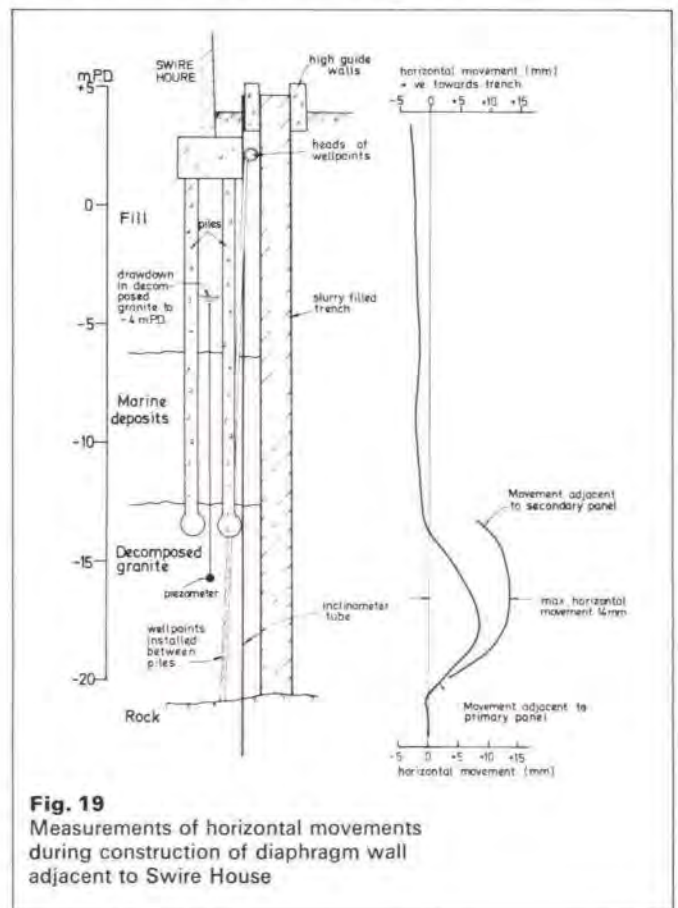

Fig. 19
Measurements of horizontal movements during construction of diaphragm wall adjacent to Swire House

Fig. 20
High guide walls
for construction
of diaphragm wall
adjacent to
Swire House
(Photo:
Richard Davies)



Fig. 21
Construction of
the diaphragm wall
adjacent to
Swire House
(Photo:
Richard Davies)

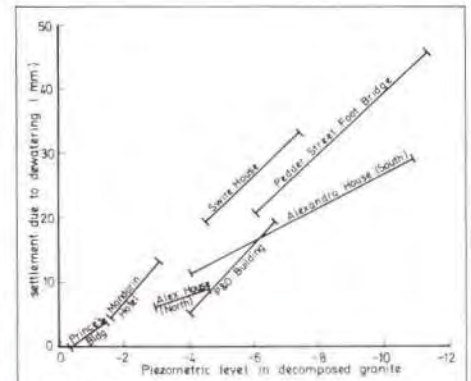

Fig. 23
Initial measurements of settlements of
high rise piled building due to
dewatering (prior to main excavation)

To limit dewatering settlements it was decided to install a groundwater recharge system at the Courts of Justice and Hong Kong Club. The purpose of the system was to maintain the head immediately behind the diaphragm wall and thus control drawdown beneath the buildings.

The recharge system comprised a number of wells installed between the buildings and the diaphragm wall and during dewatering the head in the recharge wells was maintained above ground level (Fig. 24).

The effectiveness of the recharge system in controlling settlement of the Courts of Justice is illustrated in Fig. 24 by considering the settlement at two points on either side of the station. As can be seen, the recharge system reduced the final building settlements by about 60 mm.

Ground movements due to the main excavation

After construction of the roof slab, the horizontal movement of the ground during excavation was monitored from an inclinometer tube installed between the diaphragm wall and the Courts of Justice on the southern side of the station. The results of the measurements are given for each stage of

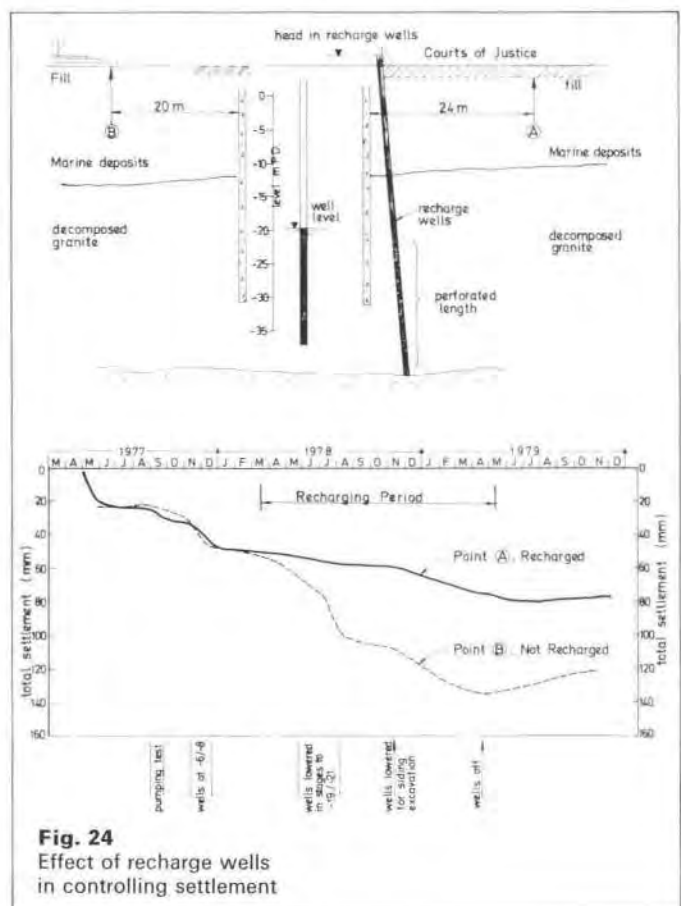
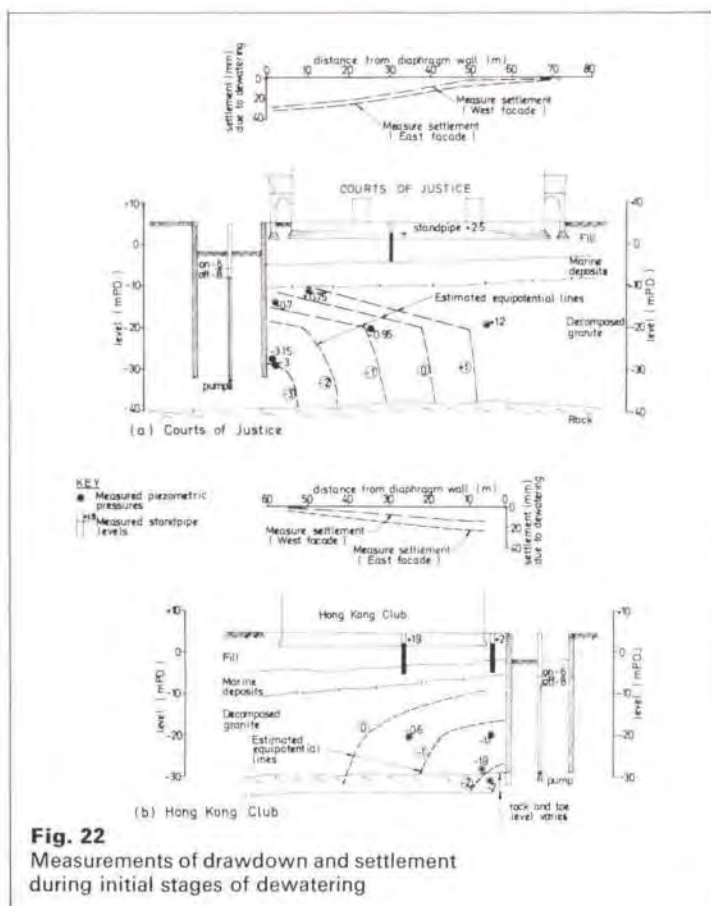

excavation in Fig. 25. Maximum horizontal movements of about 40 m were observed by the time the excavation reached the sidings level.

The settlement of the Courts of Justice during excavation below the roof slab is also shown in Fig. 25. These settlements were mainly associated with the process of excavation as the recharge system installed before excavation to concourse level virtually eliminated settlement due to dewatering.

Total settlements and building damage

By the time the basic structure of the station was finished settlements of the buildings had occurred due to diaphragm wall construction, dewatering and excavation.

The development of settlement at two points on the Courts of Justice during the entire period of construction is shown in Fig. 26. The final settlement profiles across the Courts of Justice, Hong Kong Club, Swire House and the Mandarin Hotel are given in Fig. 27. The settlement of the Mandarin Hotel is typical of the other buildings on the north side of the station. The high rise buildings to the south settled less than elsewhere and this was because dewatering was limited by the fact that, along this section of wall, a good cut-off was obtained between the diaphragm wall and rock.

As can be seen in Fig. 27, most of the buildings exhibited an overall settlement and a slight tilt towards the excavation. However, with the exception of the Courts of Justice, the distortion of the buildings was relatively small and, other than minor cracks in architectural finishes, very little damage to the buildings occurred. The only significant damage to the high rise buildings was caused by punching of the walkways into connecting buildings (e.g. between the Mandarin Hotel and Princes Building, Fig. 7). Serious damage did, however, occur at the Courts of Justice concentrated at a distance of approximately 50 m away from the diaphragm wall. At this point a 'hinge' developed on the line of a corridor between two sections of the building (Fig. 27a) and cracks were observed which increased in size up the height of the building. The cracks were first observed following settlements due to diaphragm wall construction and, during the course of the main excavation, the cracking became more serious. There was also a risk of falling plaster and finishes which led to the closure of the building during the latter stages of the station construction.

Settlements of buildings due to station construction

Conclusions

The construction of Chater Station caused considerable movements of the surrounding ground which can be attributed to the combined effects of diaphragm wall construction, dewatering and excavation. The ground movements resulted in relatively large settlements of the surrounding buildings although, with the exception of the Courts of Justice, little damage occurred.

The damage to the Courts of Justice was due to ground movements associated with diaphragm wall construction and excavation. This caused the northern two thirds of the building to tilt towards the excavation while the southern third remained nearly horizontal resulting in serious cracking at the 'hinge' point.

The most unusual feature of the behaviour of the ground during the construction of the station was the relatively large settlements observed during diaphragm wall construction. As far as the authors are aware this is the first time that such large settlements due to diaphragm wall construction have been reported and it is suggested that the settlements stem from lateral swelling of the decomposed granite during the construction

Fig. 25 Horizontal movements and settlement during excavation (Courts of Justice, west façade)

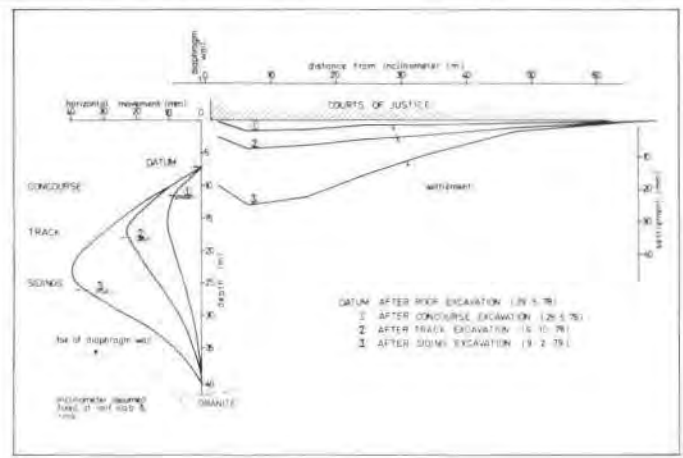

Fig. 26 Development of settlement: (Courts of Justice, west façade)

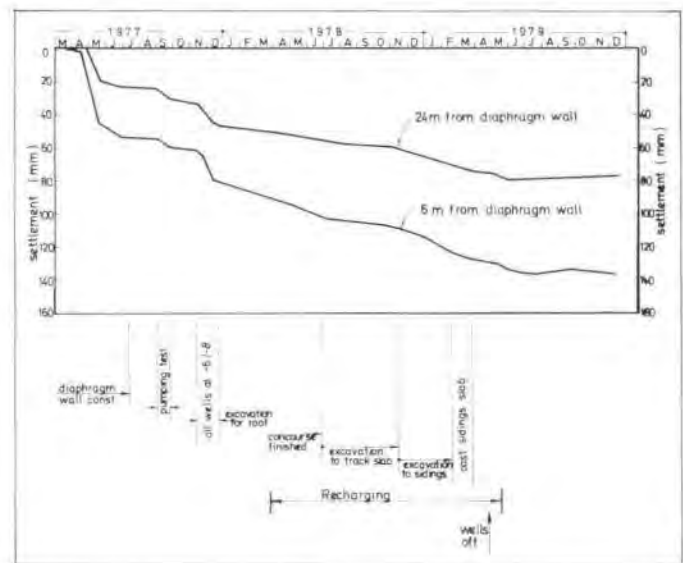
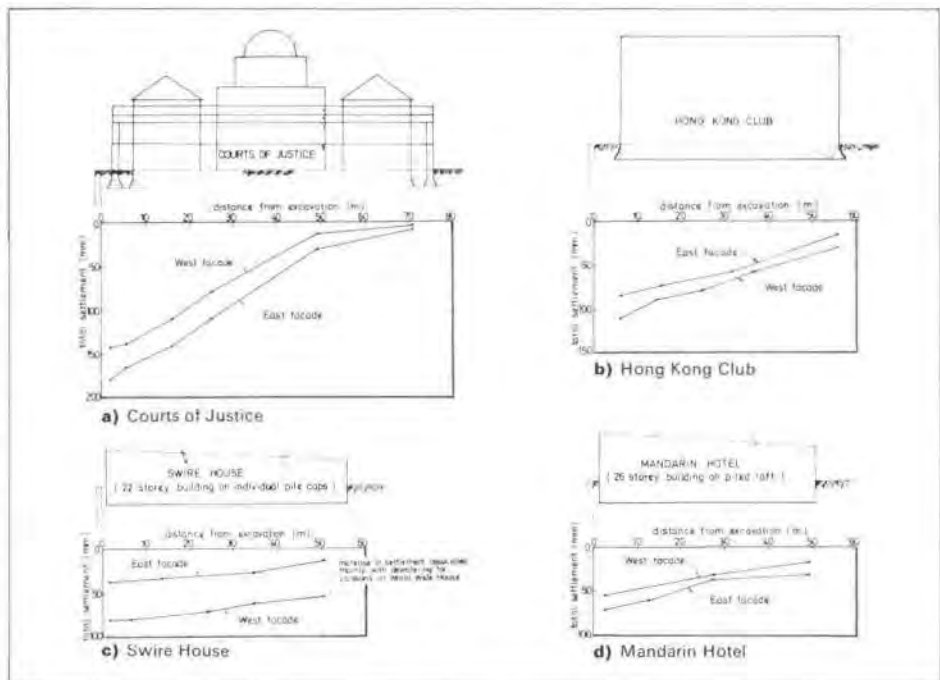

Fig. 27 Final settlements of buildings due to station construction



Acknowledgements

During construction of the station a mass of data had to be collected and analyzed and, in the light of this information, modifications made to the construction techniques. Much of this work was carried out by John Hamilton of Ove Arup and Partners who was resident on site and whose contribution is gratefully acknowledged.

The authors would also like to thank their many colleagues who contributed to the studies described in this paper and to the Metro Joint Venture for their co-operation throughout the period of construction and for their permission to publish this paper.

References

- (1) LUMB, P. The properties of decomposed granite. *Geotechnique*, 12 (3), pp. 226-243, 1962.
- (2) STROUD, M. A. and SWEENEY, D. J. A review of diaphragm walls. Discussion appendix. Institution of Civil Engineers, 1977.
- (3) LUMB, P. Report on the settlement of buildings in the Mongkok District of Kowloon, Hong Kong. Government Press, Hong Kong, 1964.

Designing for the effects of windblown sand along the new Jeddah/Riyadh/Dammam Expressway

John Redding
Andrew Lord

Introduction

Since 1976 the authors have been closely involved with the geotechnical design of two sections of the new Jeddah-Riyadh-Dammam Expressway. Both sections have to cross large tracts of loose, wind-blown sand; situations where, in the past, methods of road construction based on Western practice have often proved inappropriate.

The deficiencies in existing road practice have prompted us to develop designs more compatible with the natural desert environment and more tolerant of wind-blown sand. Our approach has been based partly on the observation of problems along existing roads and partly on a study of the mechanisms of sand transport by wind and the interactive processes that take place close to the ground surface.

The route

The two sections of road described in the paper will form part of a new Trans-Arabian Highway, linking the ports and centres of population on the Red Sea coast with those on the Arabian Gulf, via the capital, Riyadh. In order to accommodate the projected volume of traffic, the road has been designed for most of its length as a dual, three-lane, grade separated expressway.

The particular sections referred to in the paper extend from Halaban to Al Mazahimiyah and from Riyadh to Dammam; their positions are shown in Fig. 1. This figure also shows the areas of 'Nafud' characterized by an unbroken surface of wind-blown sand and dunes, together with those areas where loose sands form only a thin or discontinuous veneer. Because of their position in relation to the regional climatic systems, all these areas are periodically subject to winds strong enough to cause the sand to move. To the east of

Fig. 1
Key plan

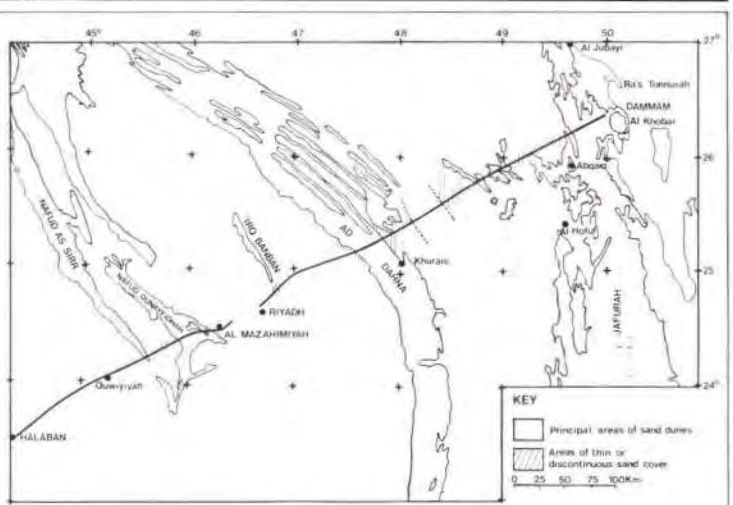

Riyadh the prevailing winds are from the north or north east so that the sand moves predominantly to the south, but along the Halaban-Mazahimiyah section the mountainous terrain results in a more confused pattern of winds, with no single sand-transport direction predominating.

Reconnaissance studies

Preliminary field studies were initiated in the summer of 1977; these studies included driving along all the existing local roads and observing and cataloguing the problems resulting from wind-blown sand. It was apparent from quite an early stage that such problems resulted not simply from the random migration of dunes or sand patches across the road (see Fig. 2), but more often than not from features of road design which actually promoted sand deposition on or close to the carriageway. The use of crash barriers (Fig. 3) most clearly illustrates this point, although sand build-up in cuttings (Fig. 4) appeared to be the most recurring problem.

As might be expected, such problems were found to be particularly severe in areas of continuous sand cover. But, since it only requires a few centimetres of sand on the road surface to constitute a driving hazard, areas with only a little sand can present a risk if the road is badly designed.

Selection of the route

Choice of route can clearly have a major influence on the extent to which a road will be affected by sand. On the western side of

Riyadh the route was fixed by the proposal to dual the existing road, but with the Riyadh-Dammam section there existed an opportunity to optimize the route on the basis of the terrain.

Selection was made following a geomorphological study based on aerial photographs and wherever possible on field surveys along the prospective route. Because of the remoteness of long sections of this route and the difficulties of access, considerable reliance had to be placed on the interpretation of aerial photographs.

In sandy areas, basically four types of sand terrain were recognized. Ranked in order of increasing risk and physical difficulty they are: (1) Flat stony or sabkha areas devoid of dunes but with a thin veneer of sand or sand in small patches (Fig. 5)

Fig. 2
Dunes on the old Riyadh-Khuraish road

Fig. 3
Sand on the road in the lee of a crash barrier

Fig. 4
Sand build-up in a shallow rock cutting

Fig. 5
Alluvial plain with thin sand cover (Class I)





Fig. 6
Sabkha surface covered by partially stabilized sand (Class II)



Fig. 7
Alluvial plain with small dunes and sand patches (Class III)



Fig. 8
'Nafud' (Class IV)

- (2) Generally flat or undulating areas of discontinuous sand cover, small isolated dunes, patches or streamers of sand; surface partly stabilized by scrub vegetation (Fig. 6)
- (3) As 2 but with clusters of small to medium size dunes or larger isolated barchan dunes (Fig. 7)
- (4) Irregular, thick, loose sand areas with the surface composed entirely of mobile dunes (Fig. 8).

Preliminary route selection was based on the expedient of trying to avoid those areas of high risk, while in areas of mixed sand terrain with patches of dunes, the road was generally routed well to the windward of the dunes.

There have, however, been many instances along the Riyadh-Dammam section of the expressway where it has proved impossible to avoid the Class 4 situation. For detailed route selection in these areas more precise field and

air photo studies have been used. To illustrate the point, a section of route lying approximately 100 km to the east of Riyadh will be considered and is shown in Fig. 9.

The line of sand hills shown form the western edge of the Ad Dahna Nafud. The hills constitute an unbroken chain of 30 m average height which extends tens of kilometres to the north and south of the route. Large star dunes form culminations along the ridge, reaching heights of up to 50 m above the adjacent playa. This is an area not only of severe sand problems but the ridge itself constitutes a formidable physical barrier.

Detailed comparison of aerial photography flown in 1955 with the 1979 project photography revealed that the largest dunes had remained essentially stationary during this period. It is thought that such large features may have reached an equilibrium condition, only experiencing small or non-linear movement⁴. The smaller dunes on the eastern and western sides of the ridge appear to move in a south-westerly direction, although the rates of movement have not been ascertained. Field studies revealed that there is a general sand drift towards the south.

The chosen route traverses the highest part of the ridge through a col lying just to the south of one of the largest dunes (see Fig. 9). The route has been orientated parallel to the dunes on the eastern part of the ridge to take advantage of the more even topography. Although the natural gradients are quite favourable along this section, a considerable amount of earthworks will be needed to satisfy the design requirements.

Wind-sand-road interactions

Faced with the difficulties of earthworks design in areas like the Ad Dahna dune belt, a detailed literature search was carried out into the mechanisms of sand and dune movement. The detailed researches of Bagnold² have been of fundamental significance to this study and the following is a summary of some of the most relevant points as they relate to the road:

- (1) A typical sandy surface has a threshold of sand movement corresponding to an average wind speed of about 16 kph. Once exceeded, sand will move in increasing quantities as the wind velocity increases.
- (2) The majority sand movement (in excess of 90%) takes place within 1 m of the ground surface.
- (3) Sand moves by (a) grains bouncing (saltating) across the surface deriving momentum from the wind while in flight and ejecting one or more grains on impact with the surface. (b) Surface grains pushed and rolled along in creep as result of impact from saltating grains. (c) Grains avalanching *en masse* down the slip face of a dune.
- (4) Across a typical desert surface the ratio of grains moving by saltation and creep remains constant at about 3:1 over a wide range of wind speeds.
- (5) Across stony or similar resilient surfaces saltating grains will bounce higher and further since they derive more momentum from the wind and lose less to the surface.
- (6) In passing across such a surface the wind effectively becomes 'under-saturated' with respect to sand, to the extent that it is actually capable of transporting twice as many grains as across a sandy surface.

A road pavement can be likened to a stony surface as being a good promoter of saltation transport and it is a familiar sight on desert roads to see 'clouds' of sand streaming across the surface (Fig. 10). This type of sand movement does not impair driver safety and since it accounts for the greatest proportion of sand in motion, it would seem logical to design the road to accommodate rather than obstruct its progress.

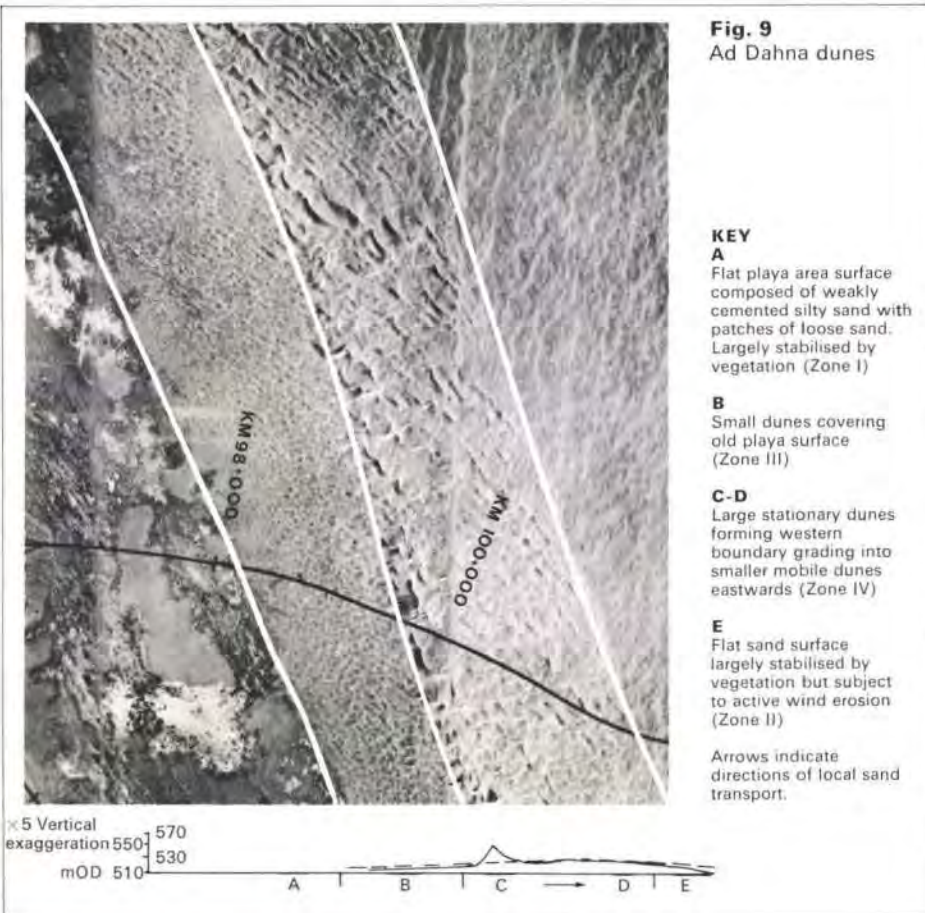

Fig. 10
Saltation across a road surface

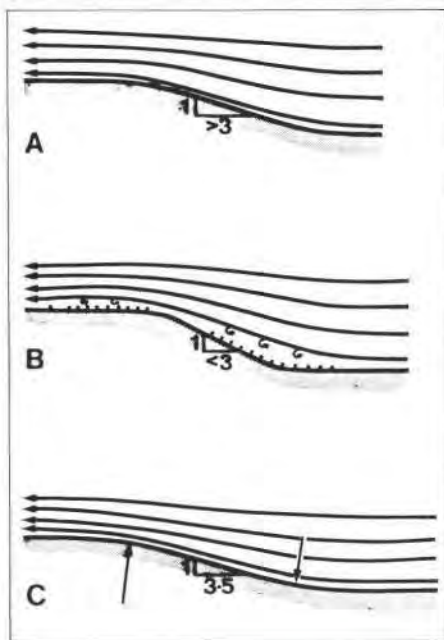

Fig. 11
Windflow
over windward
facing slopes

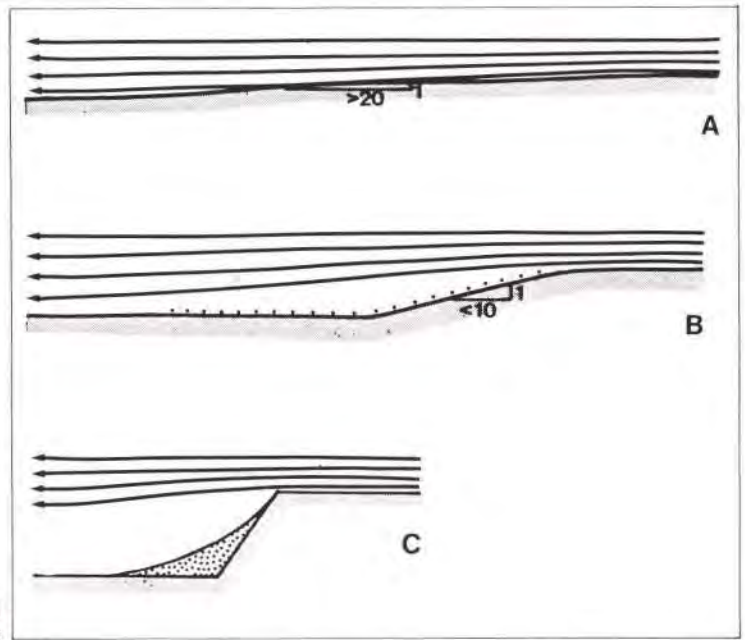

Fig. 13
Windflow
over leeward
facing slopes

Fig. 12
Sand on
the windward
face of an
embankment



Consequently the literature search was focussed on studies dealing specifically with wind and saltation movement across different types of surface, over slopes and around obstacles. The researches of Bagnold² are again highly relevant.

Certain aspects of this study will be considered in greater detail as they are particularly pertinent to earthworks design.

Windward facing slopes

As a wind is forced to rise over a slope its velocity will increase and so too will its capacity to transport sand. Provided the slope is shallow, the wind streamlines will remain parallel to the surface (Fig. 11a) and increased sand transport can occur. However, where the gradients of the slope are steeper than 1 on 3 (18°) separation is likely to occur at the toe of the slope and just behind the crest and pockets of standing, low velocity turbulence will develop in these situations (Fig. 11b). These pockets will get larger, both as the wind velocity increases and as the slope becomes steeper. Because the forward velocity in these areas of turbulence always remains below the 16 kph threshold, sand will collect and under steady state conditions, deposition will continue until a streamlined profile is established.

Using this as a model for embankment slopes, it can be appreciated that deposition at the toe of the slope does not directly represent a driving hazard, although it may block culverts and bury services, but deposition on the hard shoulder and near-side lane can be a considerable hazard.

It is quite common to see a lower part of windward embankment slopes flanked with

sand (Fig. 12) but examples of sand on the shoulder of high steep-sided embankments were also observed during the reconnaissance surveys.

Fig. 11c shows the optimum slope to achieve maximum acceleration while preventing turbulence.

Leeward facing slopes

In traversing a leeward slope, the wind will be forced to decelerate and deposition will take place from a sand 'saturated' wind. At gradients of less than 1 on 20 (3°), the wind streamlines will be able to adjust to the change in ground profile (Fig. 13a) and sand transport will continue as a combination of saltation and creep. However at increasingly steeper slopes, separation will occur and a pocket of dead or turbulent air will develop within which sand transport will cease (Fig. 13b).

The resulting deposition on leeward facing embankment slopes present no great hazard. However, again it can block culverts and bury services, and may if the sand collects on a shallow slope, form a potential hazard should the wind reverse its direction.

In cuttings, however, sand deposition can be a persistent problem, particularly if the cutting is steep-sided and the base of the cut slope lies close to the hard shoulder (Figs. 4 and 13c).

Obstacles

Any object extending into the wind flow will generate a turbulent wake which will extend downwind for a distance of up to 20 times the height of the object. Within the wake the forward velocity of the air will be greatly reduced and so this zone will tend to trap

grains in saltation. Deposition will continue in an attempt to establish a streamline profile.

Examples of this type of deposition can be seen in the sand streamers which form behind clumps of vegetation (Fig. 6) and up-standing rocks, and also in the patches of sand which develop in the lee of abandoned vehicles. The object does not have to be solid, nor does it have to be in direct contact with the ground – as shown by the ribbons of sand which form behind crash barriers (Fig. 3).

Design considerations

The foregoing is not intended to be an exhaustive discussion of the mechanisms of sand transport, but sufficient to form a basis for understanding the more important interactions between wind, sand and road, in so far as they affect design. In the following, ways are discussed in which these findings have helped to modify the standard approach to road design.

The prime object of the design has been to keep the sand moving in saltation across the road. In situations where this cannot be economically achieved, provision has been made in the design for the sand to be deposited safely in positions from whence it can be periodically removed.

Vertical alignment

The choice of vertical alignment will dictate the relative lengths and heights of cuttings and embankments. In the standard method of design the vertical alignment will normally be selected to achieve a cut/fill balance and/or a minimum volume of earthworks, within the constraints set by vertical curves and gradients.

Sand movement considerations, however, would suggest the necessity for an elevated alignment in order to cause the wind to accelerate over the road. For this reason cuttings, particularly in sand, have been kept to a minimum and the road wherever possible placed on embankment. Across flat areas with only little sand (situations 1 and 2 in 'Selection of the route') the carriageway has been raised a minimum of 0.5 m above the general ground surface, while through areas of dunes a conscious attempt has been made to keep the level of the road above that of the surrounding dunes.

There have, as might be expected, been many situations where these considerations have been overruled by economic factors. It has therefore been necessary to develop an approach to earthworks design which is sufficiently flexible to accommodate the various economic constraints.

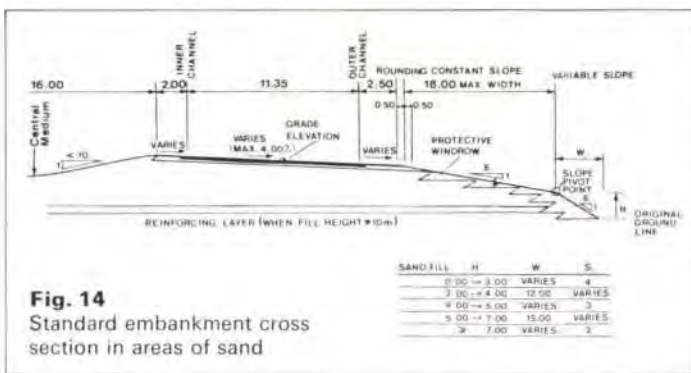

Fig. 14
Standard embankment cross section in areas of sand

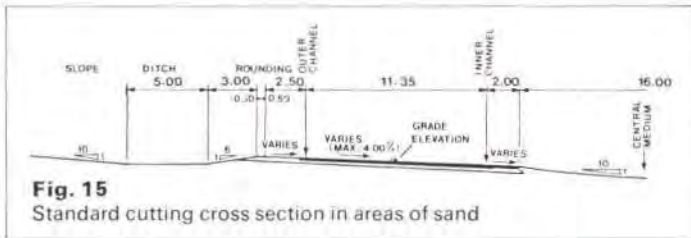

Fig. 15
Standard cutting cross section in areas of sand

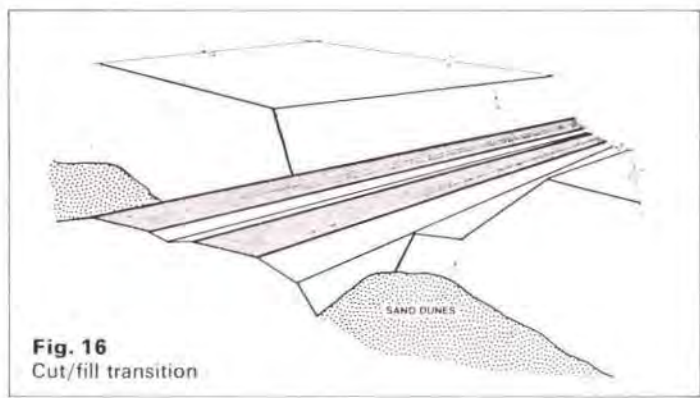

Fig. 16
Cut/fill transition

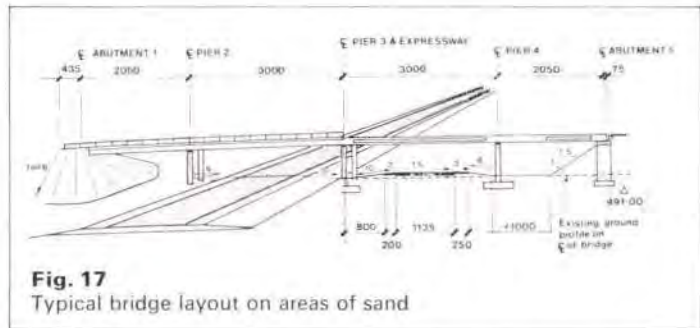

Fig. 17
Typical bridge layout on areas of sand

Embankment slopes

Approximately 70% of those lengths of road crossing sandy areas have been designed on embankment. On shallow embankments, less than 3 m high, side slopes have been set at 1 on 6 (9.5°) and the shoulders rounded to produce a streamlined profile (see Fig. 14). Sand is expected to collect at the windward toe and leeward slope, but as suggested earlier it will not constitute a hazard. The adoption of shallower slopes or an asymmetric profile would be undesirable and uneconomic.

Where sand is to be used in the construction of an embankment, the slopes and shoulders will be constructed of erosion-resistant material. Steps will be taken to ensure a smooth finish to the slopes of all embankments in order to prevent the development of sand streamers behind boulders and mounds of soil.

By adopting a 1 on 6 slope the need for safety barriers has been avoided. However, with high embankments, such shallow slopes would be uneconomic and so a graded profile will be used. This is also illustrated in Fig. 14. Substantially more sand is likely to collect at the windward toe of such embankments and this will have the effect of reducing the angle of the lower part of the slope to produce a more streamlined profile. The sand will remain in this position, however, trapped in the zone of low velocity turbulence.

Cutting slopes

In sandy areas where, for economic reasons cuttings could not be avoided, the following design methods have been adopted:

(1) In Soil

In soil and particularly loose sand, a shallow profile with side slopes no steeper than 1 on 10 (6°) has been used. Such a gradient is considered to be the steepest compatible with continued sand transport and the shallowest economic slope. Additionally a 5 m wide ditch

carriageway raised on a 0.5 m high embankment with 1 on 6 side slopes (Fig. 15). There will be a tendency for some sand to be deposited on the cut slope as a result of wind deceleration, but this will be counteracted by treating the surface to increase its resilience and to prevent erosion (see 'Surface stabilization'). The provision of the ditch will enable deposited sand to collect safely and if necessary to be periodically removed.

(2) In rock

There are very few situations along the Riyadh-Dammam section of road where rock cuttings have proved necessary in areas of sand. However, there are several on the west side, but generally in marginally sandy situations. Because it would be uneconomic and physically impractical to grade such cuttings to 1 on 10, a different policy has been adopted.

The rock will be cut at the steepest angle compatible with stability and the base of the cutting separated from the road by a minimum 3 m wide, 0.5 m deep ditch. The choice of width for the ditch will depend on the amount of sand likely to enter the cutting. It is intended that all the sand arriving at the upwind side of the cutting should fall into the ditch, so that if necessary it can be periodically removed.

Cut/fill transitions

The shallow easterly dip of the strata and the alternations of lithology and strength result in a repetitious scarp and dip slope topography along much of the route. Escarpments are situations where a transition from embankment to cut is often necessary, and they are also situations where sand may tend to accumulate. Where the wind is directed at an angle to the escarpment there will be a component of sand transport along the escarpment possibly accompanied by the movement of dunes.

Construction of a road perpendicular to the scarp will have the effect of funnelling the

wind and sand up into the cutting. For this reason the alignment has been kept as high as possible so that the transition occurs well above the level of the dunes.

The embankment and cutting slopes have been designed as previously discussed, except that the cutting has been opened out at the transition (see Fig. 16) in order to prevent localized funnelling of sand up the angle between the scarp slope and embankment.

Interchanges

Grade separated interchanges are particularly difficult situations for which to design, not least because driver safety is even more critical. Our policy has been to:

- (i) Avoid interchanges in sandy areas, and where this is not possible to:
- (ii) Design the main road on an overbridge so that the problems fall mainly on the minor road, or;
- (iii) Design the bridge as a very open structure, to allow the maximum air flow, keeping the size of the columns to a minimum, avoiding the use of safety barriers by providing a wide central median, placing the road on embankment and providing a wide verge in front of the abutments to allow any sand to collect safely. A typical design is shown in Fig. 17.

Details

In the foregoing, those major features of design have been discussed which cannot readily be changed after construction. However, there are many points of detail which nevertheless have to be considered if the design is to be efficient.

The avoidance of safety barriers has meant that a wider than normal central median has had to be used. This has been designed in the form of a shallow gravel-filled depression with profiled side slopes, capable of preventing vehicle cross-over and yet promoting saltation so as to avoid filling with sand.

Along the edge of the carriageway specially profiled extruded curbs have been designed, to channel water off the road. The slope on the curb is such as to limit the deposition of sand.

Construction of walls and fences and the growing of trees within a distance of 20 times their final height will be prohibited. Even loose mesh fences can present a problem when they become clogged with litter (Fig. 18).

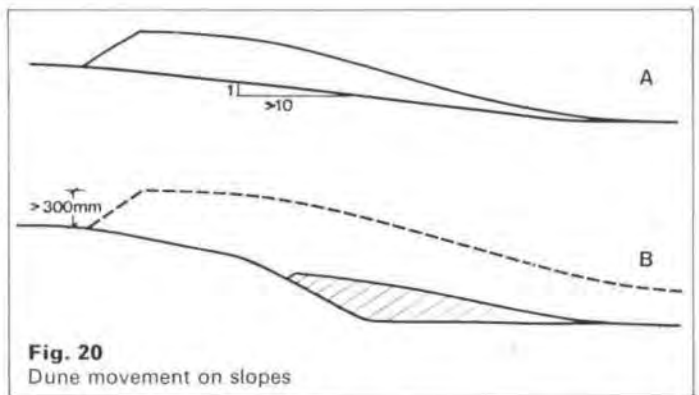
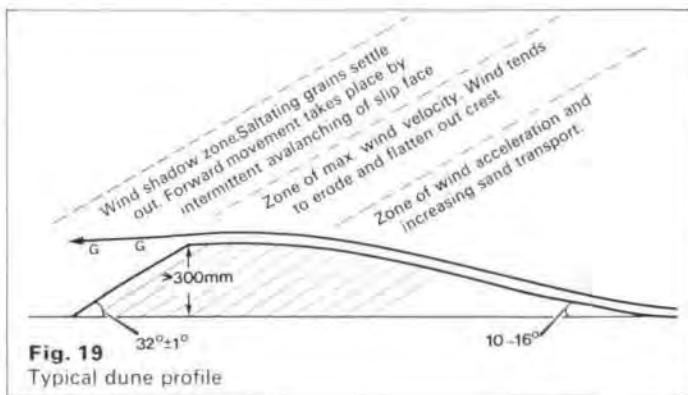

Dunes

Dunes which affect road design can be considered in two ways:

- (i) Those which lie within the zone of influence of the earthworks
- (ii) Those which lie initially outside this zone but which may subsequently migrate towards the road.

Point (i) has been partly covered in the previous section and will be further discussed in 'Surface stabilization' below. The second point constitutes one of the most uncertain aspects of road design in sandy deserts.

Despite their wide variety of type, size and morphological pattern, most mobile dunes have in common a characteristic asymmetric profile which is conserved during movement and which results from the differing mechanisms and rates of sand transport across the dune surface (Fig. 19). The slip face is the most distinguishing feature and for most desert dunes, it remains remarkably constant at an angle of $32^\circ \pm 1^\circ$. The slip face in effect preserves the integrity of the dune by preventing the escape of those grains arriving at the crest. There is a minimum height for the development of a slip face² of about 300 mm and this relates to maximum flight distance of saltating grains.

Dunes can accommodate limited changes in profile sufficient to allow them to migrate up shallow slopes (Fig. 20a). But on steep slopes, conservation of the angle of the slip face and the general flatness of the crest, will result in the dune tending to merge with the slope (Fig. 20b).

If the slope constitutes part of an embankment, the dune will be able to migrate across (as a dune) only if the height of the embankment is less than the initial slip face height (Fig. 20b). If the embankment is higher than the dune, the latter will merge into the slope and lose its slip face. With time the resulting sand body will tend to disperse, both as individual saltating grains and as a creeping patch of sand which may threaten the road.

Clearly there is a failsafe advantage to making embankment slopes in dune areas both steep enough and high enough to prevent them from being overtopped by actively moving dunes. This is implicit in the choice of vertical alignment and the design of embankment slopes, as previously discussed.

However, it is considered undesirable to rely solely on this mechanism for halting dune movement. In addition, in areas where large isolated barchan dunes are present, or where mobile dunes may lie just to the windward of a shallow cutting, a policy for immobilizing or dispersing dunes needs to be developed. Practical and effective solutions to this problem have been devised^{1,3} and have been incorporated into the design. Such methods consist of stabilizing the windward surface of the dune, either completely to prevent further movement, or selectively to cause the dune to break up. Techniques for stabilizing the surface are discussed in the final section of this paper.

However, such methods can only be applied

effectively if the dune lies more than 20 times its height away from the road. Within this distance there is a danger of the sand, trapped in the lee of the dune or that escaping from the dispersing dune, being deposited on the road. For this reason provision has been made in the design for additional earthworks to remove such dunes wherever necessary.

It is also important to maintain a careful watch on the movement of dunes and to treat them promptly should they migrate to within 20 times their height from the road.

Surface stabilization

Techniques for stabilizing a loose sand surface can be divided into two distinct types:

- (i) Those which reduce the surface wind velocity below the threshold for movement and thereby cause sand deposition. These include porous fences, panels and certain types of vegetation.
- (ii) Those which stabilize the surface by creating cohesion between the grains. These include oils, elastic polymers, chemical bonding agents and many others. They prevent creep but allow, or even enhance, saltation transport.

Because the intention in the design of the road has been to allow the natural saltation movement to continue, the techniques listed in (i) have generally been avoided. Only around bridges may it become necessary to provide additional protection from sand by depositing it upwind. In this case porous fences will be used, either in single or multiple rows. Continued deposition eventually causes clogging of the fence so that it ceases to function properly (Fig. 21). It is therefore important to ensure periodic maintenance, either to remove the sand or increase the height of the fence.



Fig. 21 Sand fencing filled with sand

Fig. 22 Dune stabilization along the old Dhahran-Abqaiq road

(Photos: Ove Arup Partnership)



Certain plants, notably grasses and Tamarisk *sp.* have a similar action when growing in dense association. Although aesthetically more attractive, they are difficult to establish and require artificial irrigation. There is a possibility that such natural protection may be employed at rest areas where facilities for maintaining the plants will exist.

All techniques which reduce the wind velocity and cause sand deposition, are not fail-safe. If maintenance is neglected there is a danger that the deposited sand may start to move again, possibly in the form of a dune.

For this reason it is proposed to use type (ii) stabilization wherever surface protection is required. Such situations will be mainly in the 'Nafud' areas, where cuttings in sand have to be made. The favoured bonding agent is an oil or oil-extended latex capable of penetrating into the surface. Since with time, sand-blasting will cause progressive erosion of the surface, the deeper the bonding-agent penetrates, the longer the protection will last. A depth of penetration of 100 mm has been specified where oil is to be used.

Application in the form of strips, orientated perpendicular to the prevailing wind, has been found to provide a more efficient use of the material. Strips 2 m wide with a gap of 4 m, have been used very successfully at Muzahimiyah, where an oil-extended latex was injected into the surface by the *Unilayer* method.

Some erosion takes place between the strips, but eventually an equilibrium is reached when the strips project into the wind flow and act as obstacles (see 'Obstacles'). Such strip application on a 1 on 10 cut slope also provides sufficient increase in surface resilience to enhance saltation and prevent sand build-up in the cutting.

Away from the road, surface treatment will also be used to immobilize or disperse dunes³. In such situations, where the surface has not been previously prepared, spraying with oil is generally acknowledged as being the most efficient method. It is important to recognize that an immobilized dune will act as a nucleus for sand and other dunes, for the reasons discussed in 'Dunes' above. This can be used to advantage to build up a stable dune barrier at a safe distance from the road, but can prove an embarrassment if the dunes are allowed to encroach too close to the road before being immobilized (Fig. 22).

References

- (1) ARAMCO, Analysis of eolian sand control, Arabian American Oil Company, New York, 1952. Unpublished report.
- (2) BAGNOLD, R. A. The physics of blown sand and desert dunes, Chapman and Hall, London, 1941.
- (3) KERR, R. C., and NIGRA, J. O. Eolian sand control. *Bulletin of the American Association of Petroleum Geologists*, 36 (8), pp. 1541-1573, 1952.
- (4) WILSON, I. G. Aeolian bedforms - their development and origins, *Sedimentology*, 191, pp. 173-210, 1972.

Load settlement characteristics of a demolition debris treated by the dry process of vibro-replacement

Wilfred Wrigley

Introduction

Foundation engineers in Britain are frequently faced with the problem of designing and constructing foundations for lightly-loaded buildings on sites covered with relatively shallow fills. In many inner city areas large numbers of buildings of Georgian to Victorian age have been demolished in an uncontrolled fashion in recent years. Commonly these older buildings had single-storey basements and the walls below ground level are often left intact after demolition. Basement areas are usually filled with loose heterogeneous demolition debris, including organic matter such as timber, and may contain voids. For

heavy structures there is usually no alternative to taking foundations down through the fill on piles or deep strip footings. For small lightly-loaded buildings, solutions such as deep foundations, or construction of new basements or replacement of the unsuitable fill materials with compacted inert material may well be prohibitively expensive.

In this situation the use of ground improvement techniques such as vibro-flotation with conventional shallow foundations is often an economical and satisfactory solution.

In this paper the use of the dry process of vibro-replacement to enable two and three-storey housing to be constructed over loosely-filled basements at a site in Edinburgh is described. In order to determine the bearing capacity and compressibility of the ground after treatment, five large-scale zone load tests were carried out on rectangular cast in situ concrete footings. Load-settlement and settlement-time characteristics of the treated ground were determined from the zone load tests. Plate load tests were also carried out to provide a qualitative assessment of the uniformity of the treated ground, and as a means of identifying areas of the site which required to be examined more rigorously with the more expensive zone load tests. The results of the plate load tests and zone load tests are compared.

Vibro-flotation has been used as a means of ground improvement in Britain since the mid-1950s and the history of the development of the process has been described in the literature¹.

The dry process of vibro-replacement, which was used at the site, is an adaptation of vibro-flotation normally used on cohesive soils and fill materials. The method was first used in Britain on demolition debris in the early 1960s and several accounts of load tests and successful building performances have been published^{1,2,3,4}.

The mechanics of the process and the complex stress conditions in treated ground beneath a loaded footing are not well understood and few data are available in the literature⁵.

Settlement-time relationships have been given for load tests carried out on treated alluvial deposits^{2,7,8} but settlement-time relationships for load tests on treated demolition debris are usually not reported. This is a little surprising since the amount of long-term settlement that will occur under working loads on treated ground must be determined with reasonable confidence in order to assess the allowable bearing pressure for shallow footings.

Current design methods are based entirely on empirical rules developed from field experience⁶ and because most demolition debris is extremely variable in composition, the rules provide at best only a first approximation of the allowable bearing pressures and likely load-settlement characteristics. The importance of a comprehensive load testing programme to check the adequacy of the ground treatment cannot be overstressed, particularly when it is proposed to construct settlement-sensitive structures.

Ground conditions

Jamaica Street is located in the northern area of the city of Edinburgh, known as the New Town. Fig. 1 is a plan showing the layout of the new housing which straddles the old street and loosely-filled basements to the north and south of the old street. Historical maps show that the site was agricultural land until at least 1751, but by 1804 it was developed with tenement housing. Photographic records show that the tenements had basements and were five

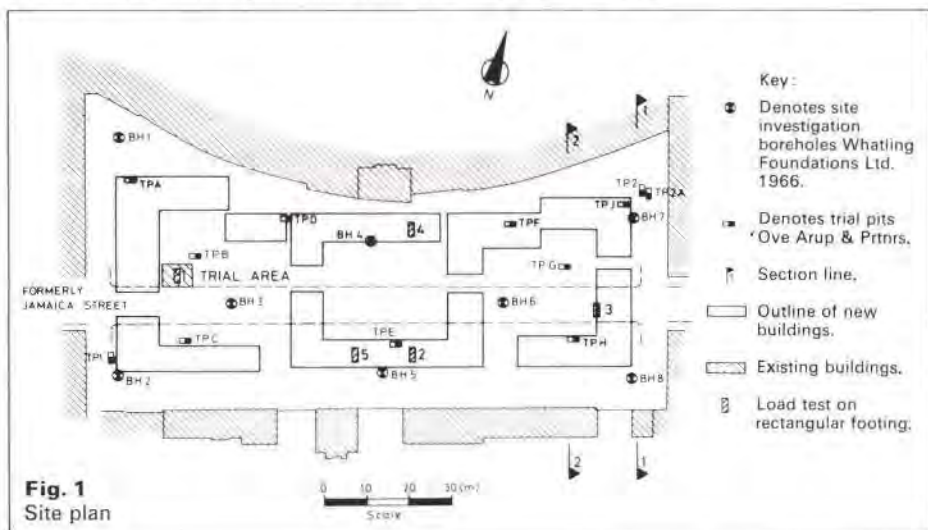

Fig. 1 Site plan

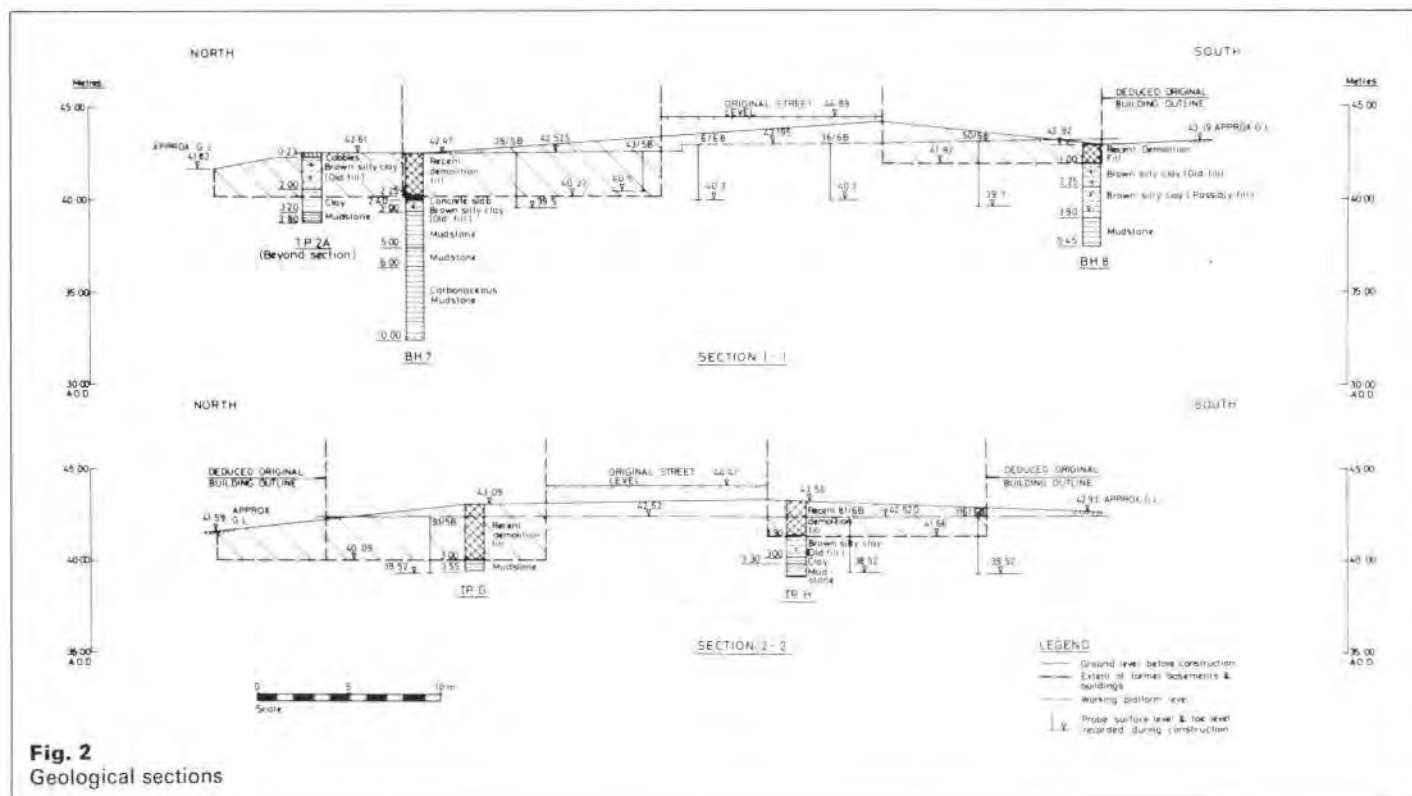

Fig. 2 Geological sections



Fig. 3
Stockpile of basement fill material
(Photos: Ove Arup Partnership)



Fig. 4
Basement wall exposed during construction

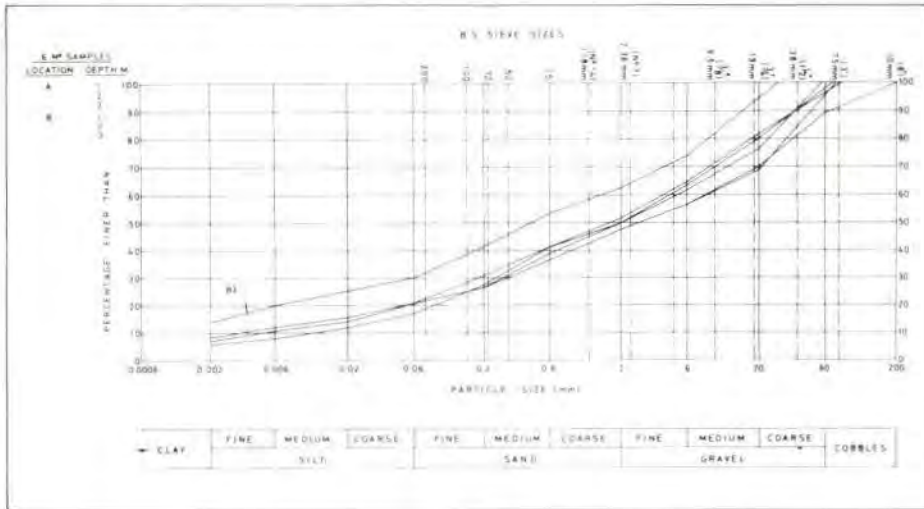

Fig. 5
Grading curves,
basement fill
material

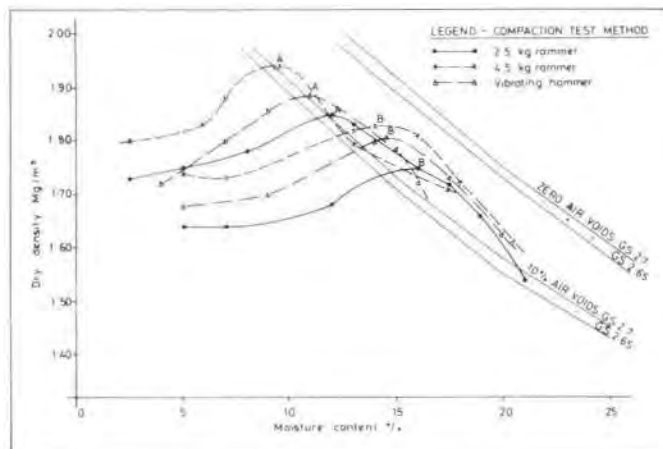

Fig. 6
Dry density moisture
content relationships

Table 1: Comparative cost estimates for alternative foundation solutions

Foundations type	Relative cost in terms of vibro-replacement March 1978 prices
(1) Mass concrete piers and suspended floors	2.3
(2) Bored piles and suspended floors	1.5
(3) Bulk excavation, replacement with granular fill compacted in layers. Strip footings, ground bearing floor	2.2
(4) Excavation, sorting, loose filling and vibro-replacement. Strip footings, ground bearing floors.	1.0

storeys in height. They were demolished in 1966 and the site was used as a car park until 1978.

Geological maps and memoirs record glacial lodgement till overlying strata, predominantly mudstone of the Calciferous Sandstone Measures of Lower Carboniferous age. A conventional site investigation was carried out in 1967 and the general configuration of the strata encountered is shown in the geological sections (Fig. 2). The location of the old basements shown in the sections was determined from the historical plans and the

level of the basement floors was proved in the trial pits. It was determined from the trial pits that the old basements were filled with very loose fill which contained large voids and pockets of timber and organic matter. Traces of water were found rarely and the water table is several metres below the old basement floor levels. A typical stockpile of the demolition debris is shown in Fig. 3 and an old basement wall, which was exposed during construction, can be seen in Fig. 4.

Grain size analyses were carried out on large bulk samples of the basement filling and it

can be seen from Fig. 5 that the material is very well graded and does not differ significantly in grain size composition in the different areas of the site.

The fill is generally matrix dominant^{1,2}, with the proportion sand size and below in the range 50 to 65% although the proportion of masonry blocks retained on the 200 mm grid varied considerably locally. The clay size fraction is of the order of 5 to 15% by dry weight.

Fig. 6 shows the results of compaction tests carried out on the proportion passing the 38 mm diameter sieve. For BS Heavy compactive effort, the optimum moisture content is 9.5 to 14% and the maximum density is 1.83 to 1.89 Mg/m³, whereas for BS Light compactive effort the optimum moisture content ranges from 12 to 16% and the maximum density is 1.76 to 1.85 Mg/m³.

The optimum moisture content for the vibrating hammer method of compaction is 11 to 14.5% and the maximum density ranges from 1.81 to 1.89 Mg/m³. The matrix moisture content of the basement fill materials at the time of the site investigation (1967) ranged from 8 to 15%. By the end of construction in 1979 the matrix moisture content ranged from 23 to 32%, increasing progressively during construction.

The soil strata encountered beneath the filled basements are firm or stiff clays of low compressibility.

Method of ground treatment

The new housing consists of one, two and three-storey concrete blockwork construction, with precast concrete floors and an outer skin of thin sandstone blocks. The houses are arranged in long terraces which have an intricate plan shape and in elevation vary in storey height irregularly. There are no internal loadbearing partitions and, as a result, foundation loads are variable in intensity. Because of the decorative thin sandstone facing and relatively high window to wall area ratio, the houses were regarded as being more sensitive to differential settlement than conventional brick and blockwork housing.

Four alternative foundation schemes were considered and the estimates of their costs in relative terms can be seen in Table 1. Ground treatment by vibro-replacement followed by the use of lightly reinforced narrow strip footings with groundbearing floor slabs, was found to be the most economical solution. In the scheme adopted, prior to treatment by vibro-replacement, the demolition debris was excavated to the old basement floor levels beneath the area of the new buildings, pockets of timber and other organic materials were removed by hand, and the selected materials were loosely returned to the excavations. Remnants of the old basement walls, foundations and floors were demolished and large blocks of masonry likely to cause obstruction to the vibro-poker were removed. The loose demolition debris was then treated with the dry process of vibro-replacement.

Dry process of vibro-replacement

The vibrator used at Jamaica Street is electrically driven, about 5 m long, weighs about 2 tonnes, hung from a crane, and is shown in operation at the site in Fig. 7. Vibrations are produced by an eccentric weight assembly enclosed in a metal casing which generates high centrifugal forces (approximately 10 tonnes) in the horizontal plane at a frequency of about 50 cycles per second with an amplitude of the order of 5–10 mm. The nose of the vibrator is tapered to aid penetration of the ground and jet nozzles emerge from the nose cone just above the tip through which compressed air is circulated.



Fig. 7
Vibroflat in operation at the site
(Photo: Ove Arup Partnership)

In the method the vibrator is used to create a cylindrical void in the ground by vibration and penetration under its own weight. On reaching the required depth the vibrator is partly withdrawn and some crushed rock aggregate (40–100 mm diameter) is tipped down the annular space which forms between the vibrator and the sides of the hole. The vibrator is then lowered back into the hole to compact the layer of aggregate and to displace radially the surrounding ground. This process is repeated until a dense stone column reaches ground level. The angular fragments of rock used to form the column at Jamaica Street consist of strong or very strong, coarse-grained, basic igneous rock, passing a 100 mm square grid but retained on a 40 mm grid, with 100% rough broken surfaces. The design required stone columns to be positioned in single rows beneath all the walls at a spacing varying between 1.44 m to 1.75 m; however, after load testing the spacing was reduced to 0.86 m in the south west quadrant of the site.

Under the ground floor slabs the stone columns were spaced at 2.5 to 3.0 m centres.

Testing programme

To prove the method of ground treatment in the site conditions, a preliminary trial was carried out. An area approximately 20 m square at the position shown in Fig. 1 was excavated, sorted and backfilled in accordance with the procedure specified for the ground treatment contract and seven stone columns were installed in the arrangement shown in Fig. 8. Approximately 20 tonnes of rock were required to form the columns which were all 4.5 m long.

Three plate load tests denoted A, B and C and one zone load test were carried out at the positions shown in Fig. 8. On completion of the preliminary load tests the stone columns were excavated and examined.

During the main ground treatment contract, five plate load tests were carried out. One was made on untreated ground, two were located on stone columns and two were on the ground between columns. It was proposed to carry out two zone load tests during the ground treatment contract. In the south west area of the site the treated ground was shown to be more compressible than anticipated and additional stone columns were installed. Four zone load tests in all were carried out during the ground treatment contract at the locations shown in Fig. 1. In the southern area of the site, Test No. 2 was carried out after completion of the initial treatment, and Test No. 5 was done on completion of retreatment of the south west area.

Excavation and examination of stone columns after load testing

The seven stone columns installed during the trial were exposed and examined after completion of the load tests. Typically, at the level of the base of the footings the stone columns were 650 to 750 mm diameter, and the diameter gradually reduced with depth to about 450 mm at 3 m depth. Generally the columns were very well compacted and all the voids between rock fragments were filled with silt and fine sand-sized material derived from the demolition fill.

In one column, located beneath zone load Test 1, a masonry block derived from the demolition fill had prevented the proper formation and compaction of the column below 3 m depth.

The material around the columns was dense to a radial distance of the order of 1.5 m from the column centres and was loose at a distance of 2.5 m to 3.0 m from the column centres.

Load test procedures

(1) Zone load tests

Zone load tests were carried out on cast in situ concrete footings bearing on a minimum of two columns and the soil between the columns. The dimensions of the concrete footings used in the tests, and the arrangement of the stone columns beneath the footings, are shown in Fig. 9. Steel beams were used to spread the load on the footing and load was applied to the spreader beams by a single hydraulic jack. The load was measured by a calibrated steel proving ring. In the preliminary zone test (No. 1), load reaction was provided by four prestressed anchors with a fixed anchor zone in rock, located at a distance sufficient to prevent any influence on settlement of the test footing or reference beam supports. In the contract zone tests, load reaction was provided by a kentledge rig. Settlement was measured at six points on the footings by dial gauge extensometers which

were attached to stable reference beams. A precise level was used to check the settlement measurements and to monitor the reference beams in relation to an Ordnance Survey bench mark at the edge of the site. Level readings were taken on the footings, reference beams and supports at the beginning and end of each cycle of loading, and when settlement was complete at the maximum load in each load cycle. In all the tests the level records of settlement agree to within +0.1 mm with dial gauge records.

In the preliminary zone test (No. 1) four cycles of loading and unloading were carried out. Load was applied in increments and each increment of load was maintained until the rate of settlement did not exceed 0.1 mm per hour. It was found that immediately after each increment of load was applied, because of the stiffness of the loading system, as the footing settled, the load as recorded by the proving ring fell off by a small percentage. The dial gauges were read initially every five minutes but as the rate of settlement decreased the frequency of the readings was reduced. When necessary, each time the dial gauges were read the load was adjusted to the correct level, but normally after a period of 15 or 20 minutes the load did not require further adjustment.

Throughout the zone load tests, records were kept of the air temperature and the test assembly was shielded from direct sunlight and precipitation to reduce temperature effects to a minimum.

(2) Plate load tests

Plate load tests were carried out on a 600 mm diameter steel plate, embedded 600 mm below ground level on a thin layer of rapid hardening cement grout. Load was applied to the plate by a hydraulic jack using a heavy vehicle as the reaction. The load was measured by a calibrated steel proving ring. Settlement was measured by four dial gauge extensometers at points located near the edge of the plate on diameters mutually at right angles. The extensometers were attached to two stable reference beams. A precise level was used to monitor the reference beams in relation to a bench mark at the edge of the site and to a local TBM.

The load was applied in 20 kN increments at 10 minute intervals and the dial gauges were read at five minute intervals. Because of the stiffness of the loading system, load as recorded by the proving ring fell off rapidly during each increment, as the plate settled.

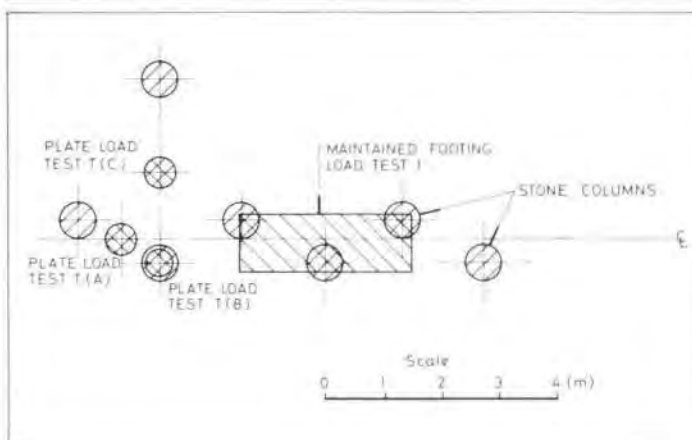

Fig. 8
Arrangement of compaction centres and load tests in the preliminary trial area

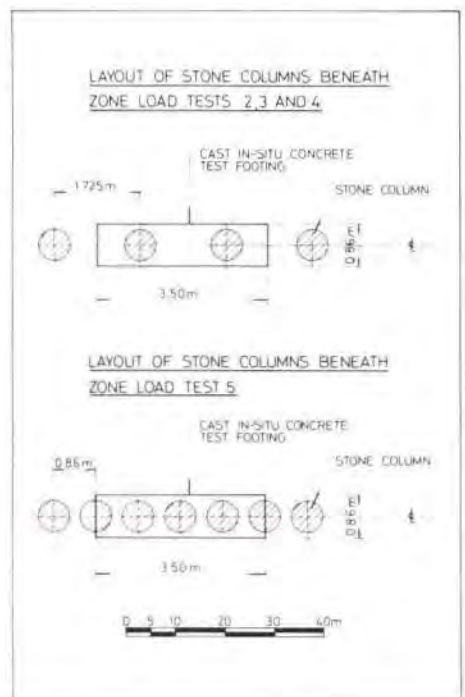

Fig. 9
Arrangement of stone columns beneath zone load test footings

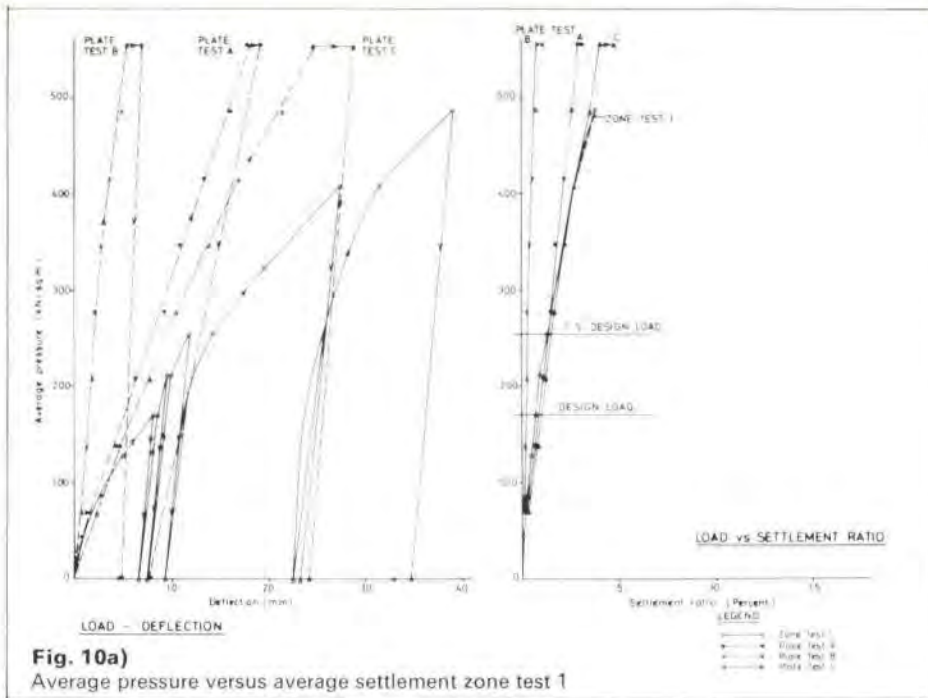

Fig. 10a)
Average pressure versus average settlement zone test 1

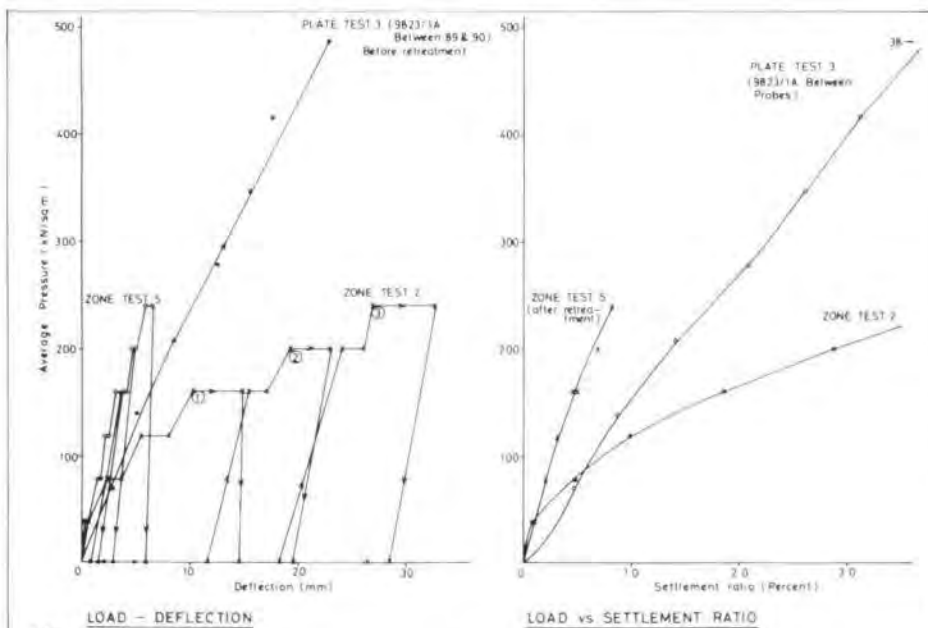

Fig. 10b)
Average pressure versus average settlement zone test 2 and 5

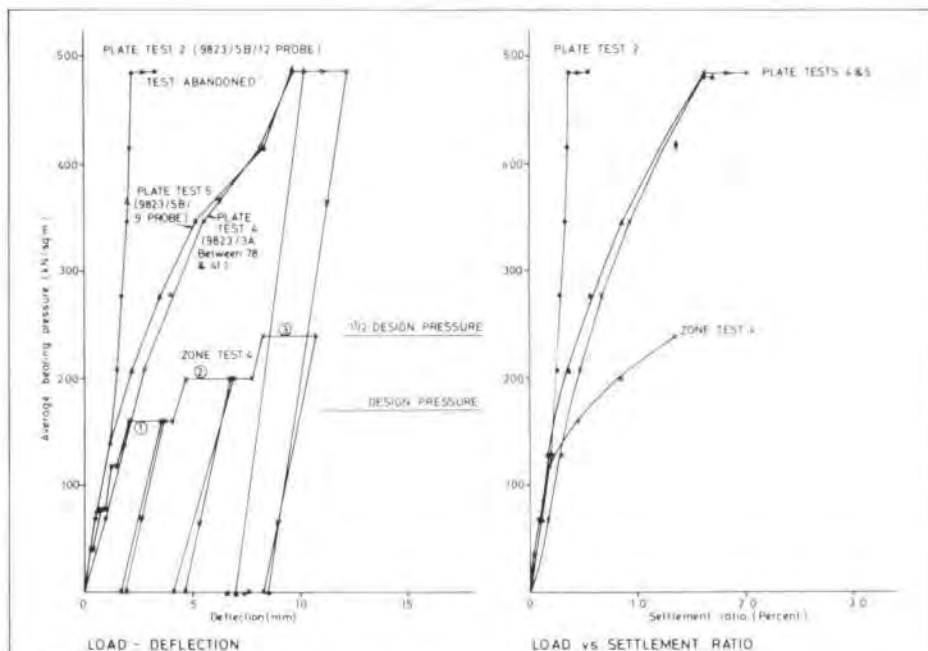

Fig. 10c)
Average pressure versus average settlement zone test 3

Treatment of zone test formation levels

In the zone tests the footing area was excavated to within 0.1 m of the formation level using a hydraulic excavator and the final 0.10 m was excavated and cleaned by hand. A form was constructed, the footings were cast within one or two hours of exposing the formation level, and the ground around the footing was levelled to the working surface.

During the progress of the ground treatment work it was observed that the vibro-poker tended to leave the ground to a depth of about 1 m in a relatively loose condition.

For Tests 3, 4 and 5, the test footings were prepared in the same way as those for zone tests 1 and 2, except that a vibrating plate compactor was used to compact the formation level. The footings for Tests 3, 4 and 5 were cast in a brick shutter, lined with two layers of polythene to prevent adhesion between the concrete and the bricks.

Load settlement relationships

(1) Zone load tests

In Fig. 10 (a-d) the relationships obtained between the average bearing pressure and the average settlement in the zone load tests are shown. It can be seen from the figures that initial parts of the pressure settlement curves are linear and parallel to the unload-reload curves for Tests 3, 4 and 5, up to an average pressure of 120 and 140 kN/m², whereas at greater pressures the relationship becomes non-linear. In Tests 1 and 2 the pressure-settlement relationship is markedly non-linear for the full range of pressures used in the tests.

At the maximum load in Cycle 1 of loading, which corresponds to the average design bearing pressure, the settlement measured at the specified terminal rate of 0.1 mm per hour ranged from 3.3 mm (Test 4) to 15.1 mm (Test 2). Geometrically, Tests 2, 3 and 4 were identical with a column spacing of 1.725 m and column lengths of 3.0 to 3.5 m and the observed differences in load settlement behaviour are considered to be due to variations in the moisture content at the time of treatment of the demolition debris, and to compaction of the test formation levels in Tests 3 and 4.

It can be seen from Fig. 10 (a-d) that all the zone load tests exhibited very large irrecoverable settlement during cyclic loading and unloading and only very small rebound movements.

The load settlement curves for zone tests 2 and 4 are plotted on logarithmic scales in Fig. 11 (a and b). Load-settlement relationships for Tests 1 and 2 can be represented on the logarithmic plots as single straight lines, whereas the relationships obtained in Tests 3, 4 and 5 form two straight lines on the logarithmic plots. In Tests 3 and 4 the change in shape of the logarithmic plots occurs at a loading of 36 tonnes (average pressure 120 kN/m²), whereas in Test 5 it occurs at a load of 43 tonnes (140 kN/m²). Compaction of the formation level beneath Test footings 3, and 4 and 5 with a vibrating plate compactor is thought to be one of the principal causes of the difference in the initial load settlement response of these tests. Compaction appears to be similar in effect to preloading to an average static pressure of about 120 to 140 kN/m².

The load-settlement relationships can be represented by an expression of the form :

$$F = C (P)^n \quad (i)$$

where,

F is the applied load or pressure

P is the average settlement of the footing

C is a coefficient equal to the applied load at unit settlement

n is an exponent.

Values of the coefficient C and the exponent n obtained for the tests at this site are given in 19

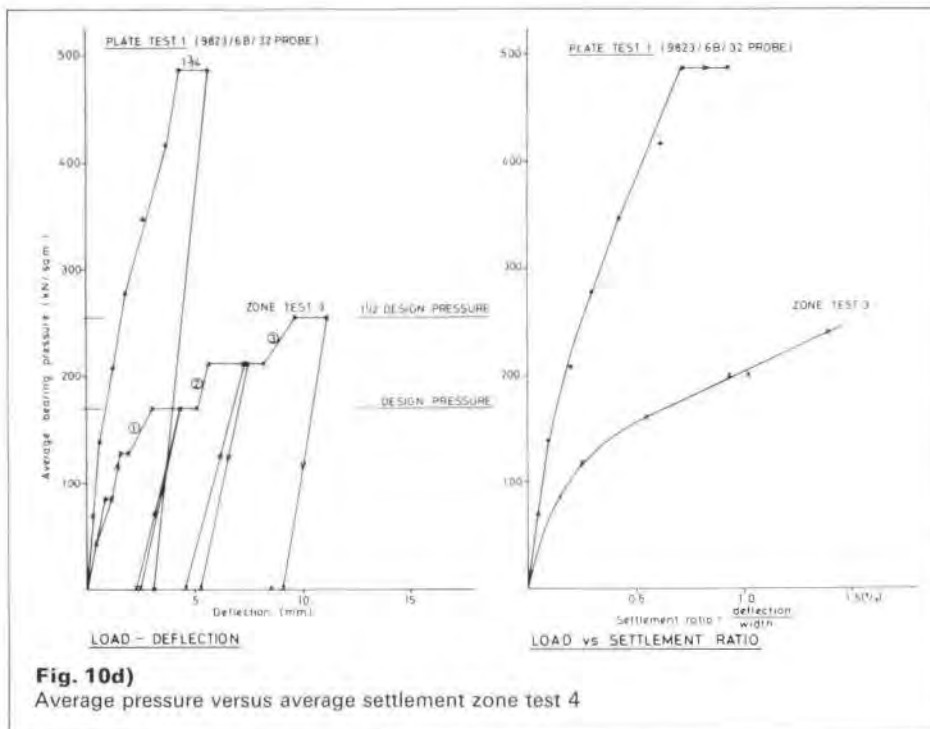

Fig. 10d)
Average pressure versus average settlement zone test 4

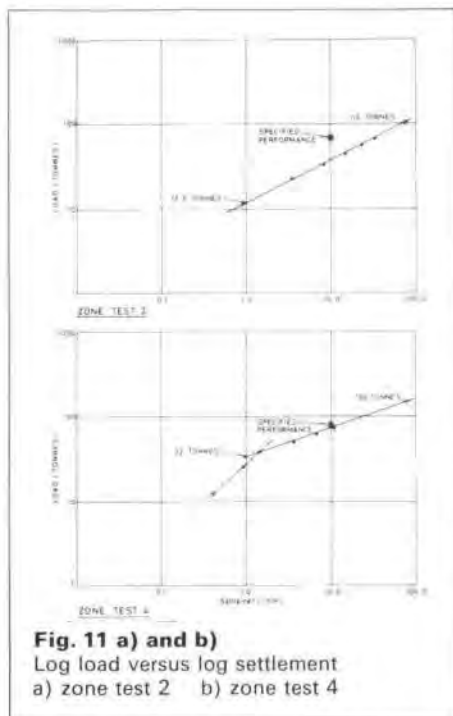

Fig. 11 a) and b)
Log load versus log settlement
a) zone test 2 b) zone test 4

Table 2: Values of coefficients C and exponent n for load/settlement relations for rectangular bearing pads

Test	Coefficient C (tonnes/mm)	Exponent n
1	12.0	0.70
2	12.5	0.51
3	22.5 26.5	0.71 0.43
4	27.5 32.0	0.92 0.35
5	15.5 26.0	1.00 0.46

the tests, but is also a result of the different rates of loading adopted. In contrast to the zone load tests, in the plate load tests long term creep movements were not measured as load increments were applied every 10 minutes irrespective of the rate of settlement resulting from the previous increment. The plate load tests probably give a reasonable estimate of the stiffness of the upper parts of the ground between the columns is seriously overestimated for long term loading, because the time effects are not taken into account.

The plate load test relationships are of limited value and cannot be used for estimating settlements under long-term loading conditions.

Table 2, where the load is measured in tonnes and the settlement in mm. When the exponent n is equal to 1 the load-settlement relationship is linear, when n is less than 1 the slope of the load-settlement graph decreases as the load increases and, if n is greater than 1, the slope of the load-settlement graph increases as the applied load increases.

Values of the coefficient C, which is similar to an initial coefficient of subgrade reaction, are in the range 12 to 32 tonnes/mm (40,000 to 100,000 kN/m²/m in terms of pressures).

(2) Plate load tests

In Figs. 10 (a-d) the relationship between the average bearing pressure and the average settlement obtained in the plate load tests are shown and they can be compared with the zone load tests located in the same areas of the site.

From the graphs of average bearing pressure against the settlement ratio (deflection/width) it can be seen that the magnitude of settlement measured in the plate load tests is always less than that measured at the corresponding pressure in the zone load tests. This difference is partly due to the difference in geometry of

Time settlement relationships

Typical time – settlement graphs obtained for load increments during the first cycle of loading in zone test 2 is shown in Fig. 12. As a load increment was applied an approximately instantaneous settlement occurred, followed by a period in which the rate of settlement decreased with time. Time settlement curves on a log time scale are shown in Fig. 13 for cycle 1 of zone test 2 and similar relationships were obtained in all the zone load tests. Similar behaviour was observed in all subsequent cycles of loading.

It may be seen from Fig. 13 that after a short initial period the settlement log time curves become linear and remain linear for periods of up to 1000 minutes after application of the load. The slope of the graphs increase as the magnitude of the load increases. This type of load settlement behaviour has been reported for a wide range of soil and rock materials^{9,10}.

Discussion of the results

The aims of the in situ zone load tests are to estimate with reasonable confidence the likely range of long term settlements under the working loads of the foundations and the factor of safety with respect to shear failure. This can best be done by modelling as closely as possible in the zone tests the actual stress conditions which will occur beneath the prototype foundations. The conditions beneath the prototype strip footings are extremely complex. The stiffness of the columns will be significantly increased by the pressure imposed by the footings on the ground between the columns and there will be a tendency towards plane strain behaviour. A rectangular shaped test area goes some way towards modelling the effects of the pressure on the ground between columns and plane strain conditions, which are not accounted for in the circular plate bearing tests.

Economic factors usually restrict the length of time that the test loads can be maintained, the number of tests which can be carried out, and the magnitudes of the loads which can be applied. In all these respects the zone load tests must be a sensible compromise.

The zone load tests were not taken to failure at the site and neither the failure mechanism nor the likely settlements at failure were determined. In the preliminary zone load test (No. 1) the factor of safety against shear failure was proved to be greater than three. Vesic¹¹ showed using model footings on sand that the ultimate capacity is developed at a settlement of the order of 10 to 15% of the width of the footing.

Extrapolation of the log load-log settlement graphs to determine the load at the 10% settlement ratio appears to result in a reasonable estimate of the ultimate capacity of the footings but the procedure cannot be recommended unless it can be shown by load testing to give safe estimates.

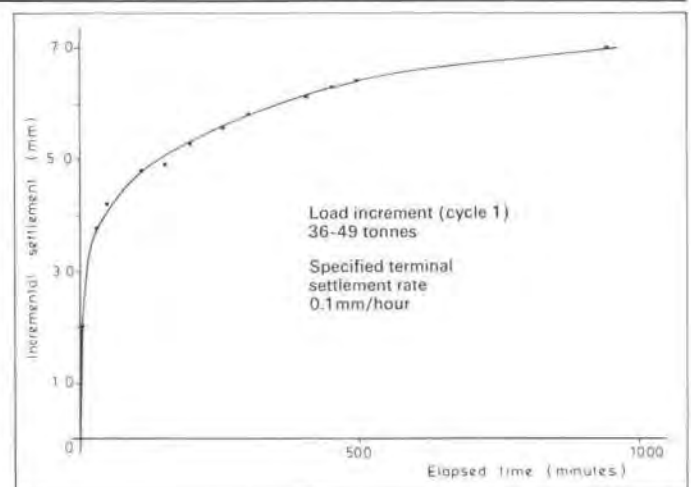

Fig. 12
Settlement time curve for a typical load increment zone test 2

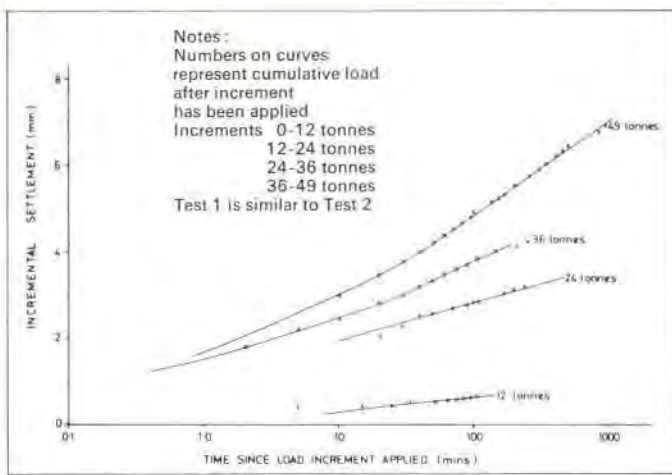

Fig. 13
Settlement versus
log time for
cycle 1 zone test 2

Table 3: Extrapolation of settlement at design load for design life

Test No	Recorded 200 minutes after load applied	20 years	Ratio 20 years settlement/200 minute settlement
1	8.05	11.8	1.47
2	15.12	23.8	1.57
3	4.3	7.9	1.84
4	3.43	9.83	2.87
5	3.76	6.07	1.61

As already mentioned, for economic and practical reasons the zone load tests have to be of short duration relative to the design life of a building; however, in order to determine the suitability of a particular ground treatment scheme an indication of the settlement to be expected in the life time of a building is required. It is suggested that an indication of the likely long-term settlement can be obtained by extrapolation of the linear settlement log-time graphs¹⁰ at the design load. Provided that the factor of safety against shear failure at design load is adequate, the method of extrapolation is unlikely to lead to an under estimate of long term settlement. The estimates of the long term settlement at design load for the zone tests at Jamaica Street are shown in Table 3.

It can be seen from Table 3 that the predicted long term settlement at the design bearing pressure for the zone load tests is in the range 6.07 mm (Test 5) to 23.8 mm (Test 2). These values range from 1.47 to 2.87 times the short term settlement.

For Tests 2, 3 and 4, in which the spacing of the stone columns was 1.725 m, the range of predicted long term settlement is 7.9 mm to 23.8 mm.

Conclusions

In difficult ground conditions such as those encountered at Jamaica Street, vibro-replacement techniques provide an economical foundation solution for relatively lightly loaded structures. Current design methods are based on empirical rules which provide only a first approximation of the likely load settlement behaviour of the treated ground. Whilst it is proposed to construct buildings which may be sensitive to differential settlement on demolition debris treated by vibro-replacement the importance of a comprehensive zone load test programme cannot be over-estimated. The zone load tests should be designed to model the prototype foundations as closely as possible and load increments should be maintained for a sufficient period of time to determine the relationship between settlement and time.

No simple relationship was established at this site, between the allowable bearing pressure

and the spacing of the stone columns. Zone tests 2, 3 and 4 were geometrically similar, but the treated ground around zone test 2 was considerably more compressible than the other areas of the site. The demolition debris at the site is very well graded and there is no obvious difference in grain size composition between the area around zone test 2 and other areas. The main reason for the difference in behaviour is that at the time when vibro-replacement was carried out, the moisture content of the demolition debris around zone test 2 was significantly higher than it was in the other areas. The dry process of vibro-replacement is inefficient at low confining pressures and the tops of the stone columns and the soil between the columns to a depth of about 1 m are not well compacted. Preparing the formation level of zone tests 3, 4 and 5 significantly improved the load-settlement characteristics and appears to be similar in effect to preloading to a pressure of 120 to 140 kN/m².

There is a linear relationship between the log of load and the log of settlement for the zone load tests, provided the settlement is measured at a reference terminal settlement rate for each load increment. No such relationship exists for the quick plate load tests in which the increments of load are applied at a constant rate, regardless of the settlement rate.

In the zone load tests, there is a linear relationship between settlement and the log of time for each load increment in all cycles of loading. After an initial period of between 10 and 40 minutes the relationship is linear to times of at least 1000 minutes. This is typical of transient creep and has been reported in the literature for a wide range of soil and rock materials. An estimate of the long term settlement during the life time of a structure can be obtained by extrapolating the settlement log time relationships. Long term creep settlements at the design load have been shown to be significant at this site.

Quick plate bearing tests of the type usually used for checking this type of work cannot be used directly to determine the likely settlements of foundations on treated demolition debris and are of limited value.

References

- (1) GREENWOOD, D. A. Mechanical improvement of soils below ground surface. Proceedings of the Institution of Civil Engineers' Conference on Ground Engineering, ICE, 1970.
- (2) THORBURN, S. and MACVICAR, R. S. L. Soil stabilization employing surface and depth vibrators. *The Structural Engineer*, 46 (10), pp. 309-316, 1968.
- (3) THORBURN, S. and MACVICAR, R. S. L. The performance of buildings founded on river alluvium. Proceedings of the British Geotechnical Society's Conference on Settlement of Structures, Cambridge, 1974. Pentech Press, 1975.
- (4) GRAY, J. Contribution to discussion. Proceedings of the Institution of Civil Engineers' Conference on Ground Treatment by Deep Compaction, ICE, 1976.
- (5) THORBURN, S. Building structures supported by stabilized ground. Proceedings of the Institution of Civil Engineers' Conference on Ground Treatment by Deep Compaction, ICE, 1976.
- (6) GREENWOOD, D. A. Contribution to discussion. Proceedings of the Institution of Civil Engineers' Conference on Ground Treatment by Deep Compaction, ICE, 1976.
- (7) McKENNA, J. M., et al. Performance of an embankment supported by stone columns in soft ground. Proceedings of the Institution of Civil Engineers' Conference on Ground Treatment by Deep Compaction, ICE, 1976.
- (8) STAAL, I. Contribution to discussion. Proceedings of the Institution of Civil Engineers' Conference on Ground Treatment by Deep Compaction, ICE, 1976.
- (9) BURLAND, J. B. and LORD, J. A. The load-deformation behaviour of Middle Chalk at Mundford, Norfolk: a comparison between full-scale performance and in situ and laboratory measurements. Proceedings of the British Geotechnical Society's Conference on In Situ Investigations in Soils and Rocks, 13-15 May 1969. BGS, 1970.
- (10) CHARLES, J. A. and DRISCOLL, R. A simple in situ load test for shallow fill. *Ground Engineering*, 14 (1), pp. 31-36, 1981.
- (11) VESIC, A. S. Bearing capacity of deep foundations in sand. *Highway Research Record*, no. 39, pp. 112-153. United States Highway Record Board, 1963.
- (12) MCGOWN, A. and McARTHUR, A. A. Morainic soil deposits and their use in low cost roads. *Roads and Road Construction*, 49 (587), pp. 388-396, 1971.

Credits

Client:

Link Housing Association

Architect:

Philip Cocker & Partners, Edinburgh

Main contractor:

J & D Ogilvie

Ground treatment Sub-contractor:

GKN Keller (Foundations) Ltd.

The design of sheet pile walls

David Henkel

Introduction

Over the years a number of publications have appeared which have led to some confusion over the philosophy and methods that should be used for the design of anchored sheet pile walls. The development of computer programs to assist in the design of sheet pile walls has provided insight into the effects of changing the variables in the system, but in concentrating on the calculations the physics of the problem have sometimes become obscured.

The purpose of this paper is to set out in simple terms the physical principles on which the design should be based and the way in which the margin of safety should be considered.

The ground

The starting point is to understand the geology and water conditions at the site. In many cases, sheet pile walls are built on waterfronts affected by tides and attention must be given to the tidal water levels in the waterway, as well as to the effects of the tides on the ground water levels.

The site investigation should be designed to establish the soil succession as well as the piezometric regime. In permeable soils the pore water pressures will respond quickly to changes in water level and loading, while in clayey soils the possibility of undrained behaviour, during loading and water level changes, will have to be considered.

In order to avoid mistakes with water pressure, it is always desirable to have the pore water pressure as an explicit term in any expression of ground pressures. If this is not done the existence of pore water pressures in the tension cracks of cohesive soils might be overlooked.

Earth pressure

In sands, gravels and any soils of relatively high permeability, effective stress methods for the calculation of both active and passive earth pressures should be used. Factors of safety should be applied to the shear strength

parameters c' and $\tan \phi'$ and not to the active pressure or the passive pressure. The factored

$$\text{parameters } c'_m = \frac{c'}{F}$$

$$\text{and } \phi'_m = \tan^{-1} \left(\frac{\tan \phi'}{F} \right) \text{ should be used to}$$

establish equilibrium.

Where there is a flow of water taking place due to different water levels behind and in front of the sheet pile wall, the pore pressures associated with the appropriate flow net should be used.

In the calculation of active earth pressures an angle of wall friction of $2/3 \phi'_m$ should in general be used. The value of the active earth pressure coefficient is not in fact very sensitive to the angle of wall friction.

For the calculation of passive pressures a value of $1/2 \phi'_m$ should be used. The passive pressure coefficient is very sensitive to the angle of wall friction.

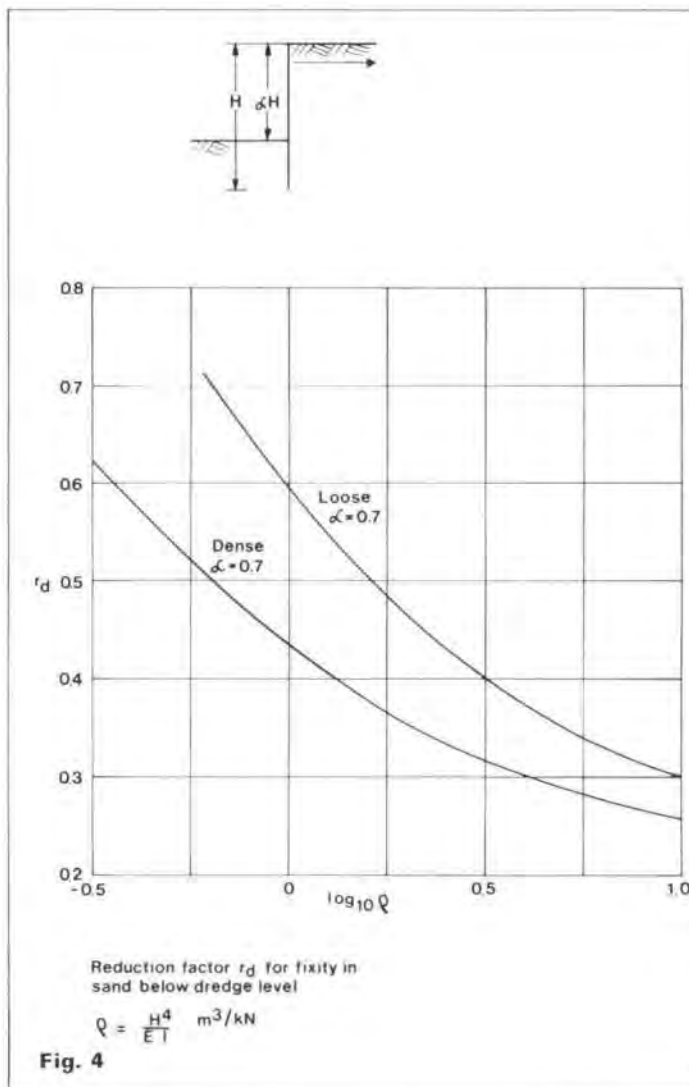
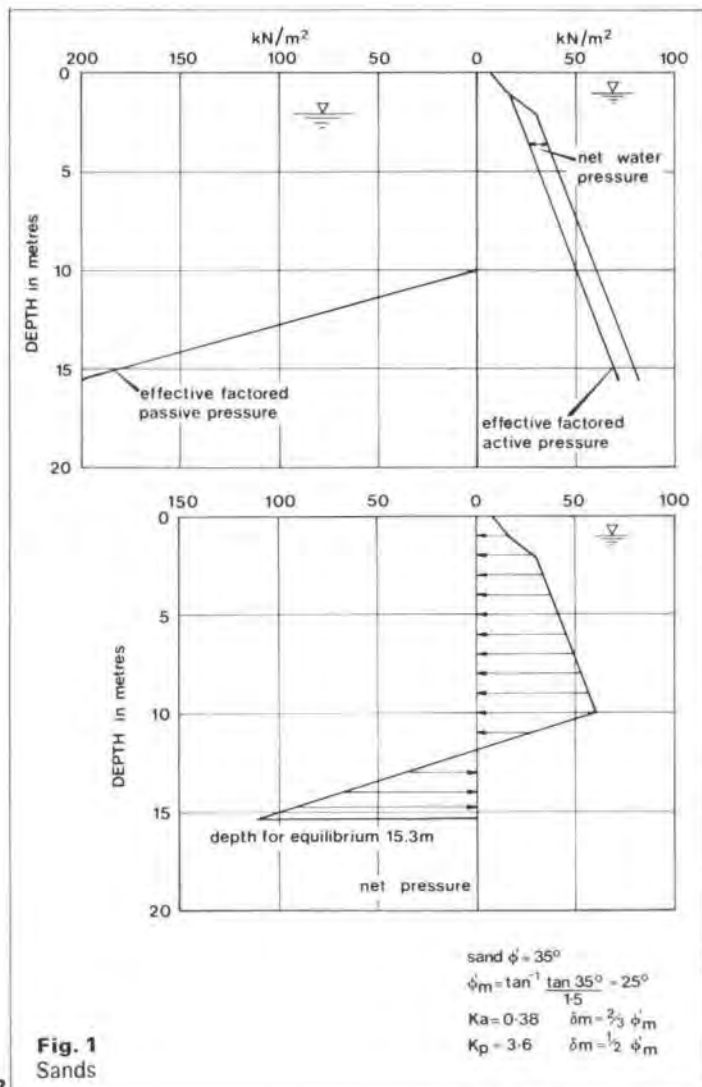
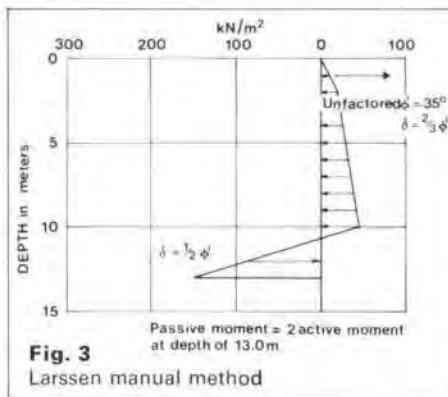
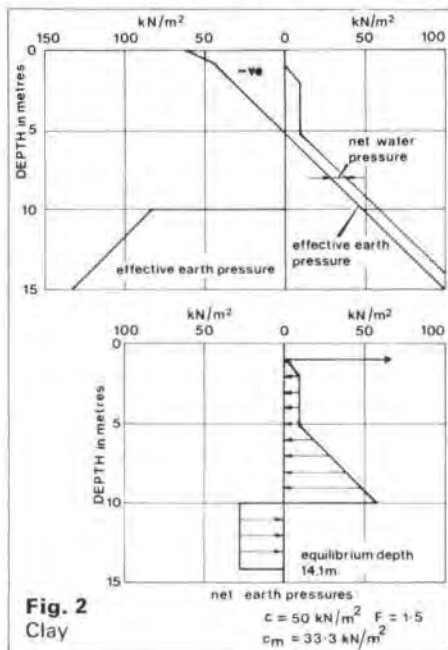

If there is any chance that the sheet piling might move with the soil, the angle of wall friction should be taken to be zero.

The general form of the active pressure intensity equation at any depth z for a $c = 0$ material will be:

$$p'_a = (\gamma z + q - u) k_a$$

where p'_a is the active pressure intensity, γ is the unit weight of soil, q is the surcharge, u is the pore water pressure, and k_a is the active earth pressure coefficient calculated using ϕ'_m .

In the same way the general form of the passive pressure equation at depth z will be:

$$p'_p = (\gamma z + q - u) k_p$$

It is important to remember that the calculations that follow are for the purpose of producing equilibrium of the system with the factored parameters. If equilibrium can be achieved then the assumed factors of safety apply.

The short-term equilibrium of clays is dealt with in terms of the undrained shear strength, c , due account being taken of the effects of anisotropy. In general, in the softer clays, the undrained shear strength of the clay on the active side will be greater than that on the passive side. The factored shear strength

$$c_m = \frac{c}{F}$$

is used in the calculations.

It is usual practice to assume that the wall cohesion c_w is one half of the appropriate factored undrained shear strength in the passive or active modes.

The general equation for the active pressure is:

$$p_a = (\gamma z + q - u - 2c_m \sqrt{1 + c_w/c_m}) + u$$

It is important to notice that the pore water pressure is dealt with explicitly. If the term within the bracket is negative it is ignored as the pressure can never be less than the pore water pressure.

The general equation for the passive pressure is:

$$p_p = (\gamma z + q - u + 2c_m \sqrt{1 + c_w/c_m}) + u$$

For long-term stability in clays use ϕ'_m and c'_m but in heavily overconsolidated clays use $c'_m = 0$ or some other low value from field data.

Factors of safety

In the past it has been customary, following Rowe (1955) and Terzaghi (1954), to apply factors of safety only to the passive side. Scandinavian practice, which seems to be more logical, is to apply factors of safety to the soil parameters as a general rule and then to satisfy equilibrium. This is the procedure we should follow.

In the design of sheet pile walls the recommended factor of safety on both cohesion and the tangent of the angle of shearing resistance in normal conditions is 1.3 to 1.5. However, when soil properties are not well known, higher values should be used.

Method of calculation

The first step in the design operation is to draw up the typical geological succession and then assign design parameters to the various strata. At the same time the design piezometric pressures related to tides or other water level variations must be defined.

Based on the design parameters and the water level data, active and passive design pressure diagrams using factored shear strength parameters are constructed as shown in Fig. 1 for sands, and in Fig. 2 for clays.

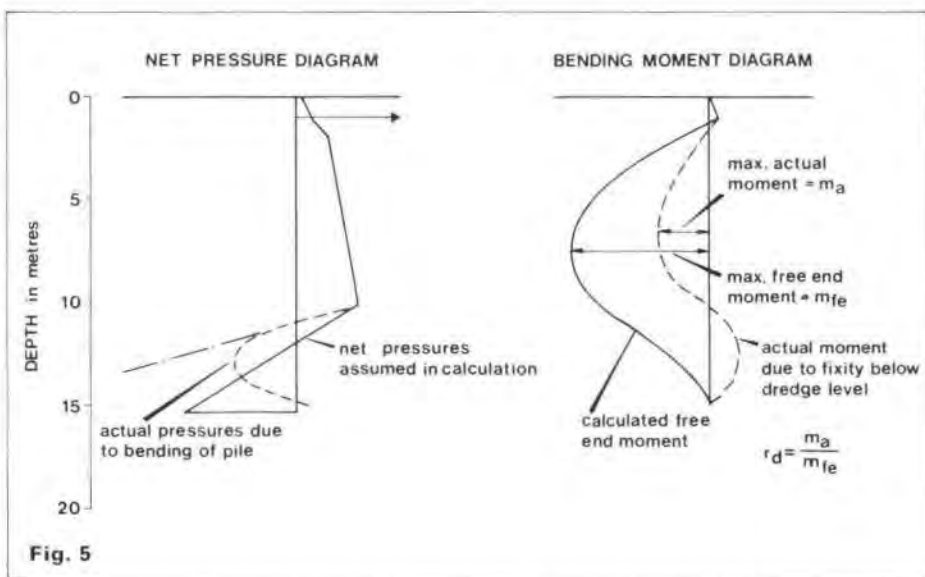

Fig. 5

By taking moments about the tie bar level the depths of penetration for equilibrium using the factored design parameters can be found.

It is important to point out that the Larssen Steel Sheet Piling Manual (1971) deals with factors of safety in terms of moments based on unfactored shear strength parameters. Use of this method can in fact lead to very low overall factors of safety against collapse.

An example of the use of the methods proposed in the Larssen Manual on the same problems dealt with in Fig. 1 is shown in Fig. 3. The comparative theoretical penetration depths below dredge level are 5.3 m for the rational method with factored shear strength parameters and 3.0 m for the Larssen Manual method.

The Larssen Manual method gives a much smaller penetration than the rational method of applying factors of safety to the shear strength parameters. It should not be used, as the safety margins are very low.

In clays in which the shear strength does not increase with depth, there is a critical height (h_c) of wall for which the passive pressure will equal the active pressure.

In the case of a dry excavation with a high external water level the critical height will be:

$$2c_m \sqrt{1 + c_w/c_m} = \gamma h_c - 2c_m \sqrt{1 + c_w/c_m}$$

$$\text{or } h_c = \frac{4c_m \sqrt{1 + c_w/c_m}}{\gamma} = \frac{4.9c_m}{\gamma}$$

In normally consolidated clays which extend to great depth, deep excavations using anchored sheet piles are not possible.

The bending moments in the sheet piling

The procedures that have been described so far have simply dealt with the equilibrium of the sheet piling using the factored shear strength parameters. The next step is to estimate the bending moments in the sheet piling and to choose the appropriate section.

At this stage it is probably useful to point out that two quite different types of sheet piling are manufactured: one has the clutch on the neutral axis and the other has the clutch at the extreme fibre distance.

In order to mobilize the full section modulus given by the manufacturers of piling with clutches on the neutral axis, it is necessary that the shearing stresses associated with this assumption can be mobilized in the clutches. In general this assumption cannot be made and it is necessary to weld the clutches of pairs of piles together in order to ensure this condition. The main effect of this assumption is on the relative flexibility of the piles

although there are also important implications on the bending resistance of the sheet piles.

The design parameters used to determine the penetration needed for equilibrium do not relate directly to the real distribution of stress at working loads or for that matter at potential collapse of the sheet pile wall.

The work of Professor Rowe in the 1950s illuminated this aspect of sheet pile wall design as he related the flexibility of the piling to the bending moments it attracted. He was able to show in a very elegant manner that, as sheet piles became more flexible, the bending moments they were required to resist decreased very dramatically.

Rowe defined flexibility ρ as H^2/EI m^3/kN and related this to a moment reduction factor r_d as is shown in Fig. 4 for dense and loose sands for ratios of wall height to total length of piling of 0.7. This moment reduction is due to fixity of the sheet piles below bed level as illustrated in Fig. 5.

The important concept is that stiffer and more expensive piles attract a greater moment. By trial and error we have to match the pile flexibility and its capacity to carry moments so that the most economical design is achieved.

In clays the long-term consolidation effects tend to reduce any effects of fixity below the dredge level, and the free end moments are used unless the piles are driven to such a depth that fixity can be obtained using the factored shear strength parameters.

General notes on steel sheet piling

Problems arise from time to time when steel sheet piling is used to protect an excavation in which the fill behind the wall is coarse or even absent. Unless the sheet piling is highly stressed, leakage through the clutches may give rise to serious problems. In a recent job the leakage through exposed sheet piling was $1.6m^3/hr./m^2$ of sheet pile wall under an average head difference of 2.75 m of water.

Problems have also arisen where factors of safety have been defined in terms of moments about a tie bar. In the extreme case for a wall with only water on both sides at the same level, the factor of safety becomes unity.

References

- (1) BRITISH STEEL CORPORATION. Larssen steel sheet piling. BSC, 1971.
- (2) ROWE, P. W. A theoretical and experimental analysis of sheet piled walls. *Institution of Civil Engineers. Proceedings*, 4 (1), pp. 32-69, 1955. (Paper No. 5989).
- (3) TERZAGHI, K. Anchored bulk heads. *American Society of Civil Engineers. Transactions*, 119, pp. 1243-1281, 1954. (Paper no. 2720).

The role of aerial photography and satellite imagery in site and route selection and appraisal

John Henry

Aerial photographs are an indispensable tool for the rapid appreciation of site characteristics and the comparison of alternative sites on an equal basis. Their contribution to a project increases with:

- Increasing project area or length
- Decreasing time for preliminary studies
- Access difficulties
- More complex and variable sites
- The paucity of topographic and geologic mapping
- The degree of recent change occurring on a site.

Aerial photography is, relatively, an old timer in the field of remote sensing. It has been a major survey tool since World War II and is still the main source of information for large area survey. The term remote sensing has come into being with the advent of image taking satellites. The pictures which satellites produce are line-scan images, much like a television picture and cannot properly be called photographs. However both aircraft and satellite record or sense information of their subject from a distant or remote position and hence the jargon—remote sensing.

In all our jobs at preliminary or feasibility stage, we use existing air photography or satellite imagery.

This paper outlines the attributes of standard photographs and images (see Table 1) and, by example, how we have used them to advantage on various jobs.

The chief advantage of aerial photography is the ability to see landscapes in three dimensions in considerable detail. Slopes and heights can be readily obtained; these facts are basic to any planning and design.

For a geomorphologist reading an air photo,

slope form, combined with details of soil tone and texture, vegetation type and condition, and drainage pattern and density, can yield considerable information on soil or rock type, slope stability, relative strength and permeability. The level of detail is, of course, dependent on photo scale.

The main advantages of satellite imagery are its extensive and frequent coverage. Regional geological structures are apparent. Seasonal differences between wet and dry seasons can be assessed. Large areas can be covered and comparisons between widely separated locations can be made on an equal and common basis. The major drawback is the poor resolution and unsuitability of the scale for detailed study. Their main usefulness comes into play in poorly mapped areas where vast developments are contemplated.

Both forms of remote sensing offer the sub-regional to regional perspective so vital to making comparisons and choices between sites and routes. They both allow the opportunity to review problem areas and refresh the memory, unlike field notes. They both should substantially reduce time and cost of site investigation by anticipating problems and complexities and providing a systematic framework for organizing a site investigation.

Case studies

I have chosen five jobs to illustrate (a) the range in size and location (b) the variation of detail achieved or required (c) the different job stages at which we have become involved (d) geotechnical variety and (e) the variety of end product tailored to the job's requirements.

Spoondell, Dunstable, Bedfordshire

This is a small (less than 1 ha) job involving a shallow landslip in a 32° fill slope immediately behind newly completed but unoccupied houses. The client was the South Bedfordshire District Council who was anxious to regrade the slope and have a guarantee that the slip would not recur before allowing tenants to move into the houses. They had attempted to regrade the existing slip themselves and it had slipped again.

In order to design for a stable fill slope it was essential to know the nature and variation of the fill, and the nature of drainage into the fill. We studied large-scale Ordnance Survey maps of the area and, for the post-war period, all dates of photography.

From the maps we discovered that chalk had been quarried since before 1878. Old parts had been backfilled since new parts of the quarry were opened. No heights were given within the area of quarrying. From a site visit and inspection of existing samples we could see that fill slopes up to 35° were perfectly stable and that virtually all the samples had evenly distributed minute chalk fragments. Even a small amount of calcium carbonate, well-distributed in a soil, will give a shearing resistance commonly exceeding 30°.

The slip in question was isolated. A small scarp was formed and slipped material came to rest at 23°.

From the aerial photography we could see the quarry floor and an unexcavated ridge or ramp just behind the location of the landslip. We could see that in the sequence of filling, the ramp was left to the last. We located it by a trial trench.

In the 1976 photos we could see a slip in the fill at this point and dark, almost black spoil, which was later, in the site investigation confirmed to be very clayey. Depth of fill in various parts could be estimated. It was reasoned on this evidence that an adverse combination of clayey fill with a supply of water provided at the low point on the old track produced a succession of slips, the most recent ones being merely a reactivation along existing slip surfaces.

The desk study information was compiled in map form by enlarging the photos in our copy camera and tracing the salient features onto the 1:1250 site plan. Our understanding of local quarry history, both on site and on adjoining property, was only possible from an historical aerial viewpoint.

On this job we entered the scene after the client had tried to remedy a slope failure, and another consultant had undertaken a conventional site investigation which failed to explain what was happening.

On the basis of the desk study, confirmed by two trial pits, specific drainage measures and slope regrading were designed to stabilize the slope and satisfy the client.

Table 1

	Aerial Photography	Satellite Imagery
Standard product	B & W contact print 230mm × 230mm – from a variety of commercial and government sources	False colour enlargement of 70mm ² neg. – from NASA
Typical scale range	1:5,000 – 1:40,000	1:250,000 – 1:1,000,000 variations of same negative
Coverage	1km × 1km – 8km × 8km	185km × 185km
Resolution	ground resolution 1m ² to 3-4m ²	56m × 80m – to improve to 20m × 20m
Stereo, i.e. 3-dimensional viewing	Yes. Usually with × 2 vertical exaggeration	No. Only 10% overlap. Awaiting future developments
Frequency	Most countries at least one at small-scale. Developed areas every 5-10 years. In UK since World War II Generally since 1960s	Capability: every 18 days. In practice once a good image is available in each season, coverage has been quarterly, semi-annually since 1972
Availability	Generally available but subject to national security policies. Usually no problems with government client	To anyone
Lead time	1 to 'several' weeks	3-6 weeks



Fig. 1

Spoondell, Dunstable, Bedfordshire
An enlargement of an aerial photograph taken in June, 1976 before construction shows (A) the area of fill and the fill scarp, (B) an existing landslip (C) a depression where runoff water collected and infiltrated and (D) the position of houses subsequently built.
(Photo: Hunting Surveys Ltd.)



Fig. 2a)

North West New Territories, Hong Kong

This portion of the North West New Territories shows the basic landscape elements. A polder landscape of large duck ponds on former marsh and tidal flats occupies most of the frame. In the lower left corner are densely populated valleys in the rugged hills of the Repulse Bay lavas. China lies across the river in the upper left hand corner. (Photo : Government of Hong Kong)

Fig. 2b)

North West New Territories, Hong Kong

A typical North West New Territories scene of duck farms backed by hills. The development of a new city of 1.65 m. people in this type of landscape involved geotechnical problems such as quarry location and development to meet massive landfill requirements, instability of steep slopes and compressible marine soils. Aerial photographic interpretation enabled the rapid regional overview of geotechnical conditions and existing land use necessary to compare various planning strategies. (Photo : John Henry)

North West New Territories, Hong Kong

The government of Hong Kong is planning to build a city for 1,650,000 – the size of Birmingham – in the N W New Territories. The project will involve a major container port, and motorway links with the rest of the colony, rail links with China, major land reclamation and, of course, a massive building programme.

At the time several major planning strategies were being formulated and it was vital to know how much they would cost in terms of landfill, borrow material, tunnelling, road and rail construction, and land costs.

The NW New Territories has roughly 3/4 of

Hong Kong's limited flat land. Land is a bit of a euphemism as the land is near sea level and covered with fish ponds in parts. Much of the flat areas are soft marine clays. Surrounding these are steep rugged hills of granites, volcanics and metasediments. The hills are fringed and mantled with colluvial deposits, some of which are unstable. The map produced showed soft marine clays, unstable slopes, potential quarry areas, well-drained terrace lands and areas with severe gullying, on a revised geological base at 1:20,000 scale.

Consortium members, Ove Arup Hong Kong Ltd., Kampsax-Kruger Ltd., Urbis Planning Consultants and Voorhees Transportation Consultants, assembled a team which included

geotechnical, transportation and drainage engineers, agricultural planners, a geologist, and a geomorphologist. In addition to the production of a photogeological report I was able to look at several specific questions as they arose, relating to land drainage, mountain road routes, erosion control in regional parks and agricultural potential. On this last item it transpired that the engineering soils map worked perfectly well as an agricultural soils map with a change of jargon. The end product was a 1:20,000 scale map with an accompanying report. The documents are intended for internal use by consortium members. They may be published at a reduced scale as an appendix of working papers with the consortium's recommendations but there was no public enquiry to prepare for in this case.

A35 Charmouth, Dorset – by-pass alternatives

The present A35 goes through the centre of several small towns and villages en route to, and on, the Dorset coast. In this study for the South West Road Construction Unit we undertook to examine designated alternative by-pass routes around five villages.

The study included an appraisal of the geology, geomorphology and hydrology of the area; an assessment of the side slopes of cuttings and embankments for the roadworks including reference to any special measures required to achieve or maintain stability; foundation requirements for structures; guidance on the method of excavation and suitability for use as fill of the materials to be encountered in the area and a discussion of the geotechnical advantages and disadvantages of the alternative routes. This included a discussion of any realignment that might be advantageous from a geotechnical viewpoint.

The report had to be produced to a high visual standard for presentation before public inquiry. I have chosen the Charmouth section for illustration because of geological variability and serious slope instability problems. This represents about 25% of the route length studied.

The role of air photo interpretation was to add

details of slope instability, drainage – particularly spring lines – and to check geological boundary details to supplement existing 1:10,560 mapping. For the area with greatest topographical and slope instability problems the existing mapping was done at 1:63,360, last revised in 1895 and was, understandably, very general.

Aerial photography taken in March 1976 at 1:7,500 and October 1972 at 1:12,000 was examined. The spring photography was especially useful because the trees were leafless, the water table was high, and, of course, there was more detail. However, the smaller scale of 1:12,000 was useful for making correlations over greater distances. Both scales are relatively large for route work compared to smaller scales used overseas, but they were appropriate to this job because (a) of the geological and geomorphological details, and (b) the relatively small route length, about 16 km in a 2 km x 4 km area. Also, they were available.

The geology, briefly, consists of Cretaceous sandstones and clays dipping south at 2°, lying unconformably over faulted Lias clays and sandstones dipping west at 3°. Despite the gentle dips the effect is that different Lias strata, changing from east to west, come into contact with Cretaceous deposits which vary laterally. Much of the contact area is obscured by landslips. None of the route alternatives

were able to entirely avoid unstable soils. The slope form and landslip occurrence corresponded well with geological units on 1:10,000 scale mapping in the eastern part of the study area. Therefore the photo interpretation in the western part was quite confident and, in the light of site investigation, required very little adjustment. There were also some minor revisions of geological boundaries in the area already mapped by the geological survey. They had not used aerial photographs.

Following the desk study of all by-pass sections in December 1978 and January 1979, all the routes were checked during a walkover survey and preliminary geological maps were produced for the interim report in March. Borehole investigation was undertaken in the slip areas and in proposed deep cuttings to establish depth of failure planes, water table and engineering parameters of materials encountered. Site investigation was completed by September 1979 and the final report was submitted by December 1979.

Aerial photographic interpretation was essential to this study because of the detail required, the difficulty of mapping extensive, shallow slope instability forms, the large area that, practically speaking, was not properly mapped, and the spatial, three dimensional problems posed by the faulting beneath the geological unconformity.

Queensland power stations

The State Electricity Commission of Queensland had designated approximate areas where it wanted Ove Arup and Partners Australia to define specific sites and work out comparative costs for a coal-fired power station to use coal from its Curragh Mine. In addition, for a further region they wanted sites defined and major constraints described only. We received the commission in early December and the report was due at the end of January.

A team comprising two power station experts from the UK Central Electricity Generating Board, two coastal and water engineers, a geotechnical engineer, a geomorphologist, the senior partner of Australia, John Nutt, and the Brisbane partner, Ron Bergen, was assembled in Brisbane by 9 December. Preparatory desk study of topographical maps, geological maps, and memoirs and aerial photography for all the sites was carried out in four days and the team plus two of the clients began a blitz on 12 sites, which was completed in seven days. The preliminary geological maps for six of the sites were completed in three days.

The level of inquiry for the remaining six sites meant that geological maps were not required. The desk study and fieldwork and draft interim geotechnical report were completed in four days.

In this, the chief value of the air photos was for rapid reconnaissance. None of the team present had seen any of the sites. Given the brief time available for the engineers to view each site, it was essential that we produce sketch maps, listing major features to see, and review physical access to each site. All the sites were enclosed grazing or farmland. Each night we briefed the team on what they were to see the next day. In addition, since we had chartered aircraft we could instruct the pilots to overfly and circle all the sites.

One site, Broadmount, with an area of 25km², was on a river near the coast. One area of 100 km² in which we selected four sites was downwind from a large town, Rockhampton, a centre for industrial expansion. One inland site was near the intended source of coal, Curragh. For these six sites a plant layout had to be proposed, as well as costs development of the site preparation,

coal and water transport to the site and electricity transmission to the consumer.

In a further area of 100 km², downwind from Toowoomba, all potentially suitable sites had to be defined but not costed.

A typical inland site required a water reservoir site, a tailing dam site, a coal stock piling area, an area capable of bearing very heavy generating plant and access by railway. It was assumed that water would have to be piped to the inland sites.

The coastal river site was the only one with soft ground problems. The remainder had weathered bedrock at or near the surface. The main geotechnical considerations were rock rippability and permeability at dam sites, considerations which required a site investigation once a plant layout was determined. Generally speaking the site reconnaissance turned around primarily topographic considerations of dam site, rail access and smoke dispersal.

Since the best scale of topographic map available was 1:100,000, the aerial photographs at larger scales were able to provide more topographic detail.

Botswana feeder roads

Botswana Road Department required 33 gazetted roads totalling 4000 km to be studied on economic, social and engineering criteria in order to rank them in order of priority for inclusion in their five year plan beginning in 1986. This was done in Phase I. The first 1000 km recommended proceeded to Phase II. Reports have been written, on a route-by-route basis, to include a route inventory, water sources and construction material sources. The work was funded by World Bank loans. The reports are intended to brief potential donors of the benefits and costs of projects they might wish to finance.

Phase I material survey was carried out in London on Landsat imagery. The 4000 km was examined at 1:250,000 scale in six weeks. We used a standard false colour image and the scale chosen was the largest magnification feasible before grain began to interfere. I examined 15 km wide corridors such as I would examine air photos. I could distinguish major geological units, major drainage, sand dunes and major calcrete deposits. The ground resolution was a significant limitation – a feature has to be 80 m × 56 m, or contrasting enough to dominate an area that size, in order to register. Nevertheless, given the magnitude of the task, the need to compare widely

separated areas consistently, the short time available, and the very basic level of information necessary to eliminate 3/4 of the routes, Landsat imagery was ideal. It took 25 images compared with approximately 2000 aerial photographs to cover the initial 33 routes.

Phase II was the standard air photo interpretation and rapid field checking. Air photos provided more detail of course; however, the colour discrimination of Landsat enabled boundaries to be drawn in some areas of gradual transition where photo grey tones were inadequate. The air photographs fitted well with satellite imaging for major interpretation.



Figs. 3a) to c)
Botswana feeder roads

a) Satellite imagery was used in phase one to evaluate and compare 32 routes scattered throughout Botswana. The Chobe River crosses the image to join the Zambesi River in the upper right corner. The Kalahari Desert lies to south. The Okavango Delta lies to the north of the Chobe. This route studied links Ngoma Bridge with Katchitau. (Photo: courtesy Hunting Surveys Ltd.)

b) The routes recommended in phase one for more detailed examination were studied in phase two. Aerial photographs studied under the stereoscope showed soils and topographical details. This photo shows Ngoma bridge and the narrow strip of arable land between the desert and the delta. (Photo: Government of Botswana)

c) Near Ngoma Bridge looking west the gently pediment slopes from the low basalt escarpment to the Okavanga Delta. (Photo: John Henry)



Summary

Aerial photographs are a standard source of information for Geotechnics' desk studies and field reconnaissance. For small sites in the UK the historical aspect of air photos is particularly useful.

For overseas projects where larger areas or lengths are involved and mapping is often inadequate, air photos and more recently, satellite imagery, provide a synopsis of topographical, geological, land use and hydrological information which may otherwise be non-existent.

Table 2: Summary of case studies

<i>Job name, Location and Date</i>	<i>Size Area km² or Length km</i>	<i>Existing information Geological/topographical</i>	<i>Available Photography/Imagery</i>	<i>Job stage</i>	<i>Level of information required</i>	<i>Quality of reporting required end product</i>	<i>Major remote sensing contribution</i>
Spoondell, Dunstable, Beds. UK Oct. '79 – Aug. 1980	<.01	1:10,560 Geol. M.S. 1:1250 topography	a.p. 1961 1968 1976 1:10,000 scale	remedial work to complete housing project	sufficient for detailed design of drainage and regrading	standard linework for client's internal use and records	historical
Charmouth, Dorset, UK Dec. '77 – Mar. '78	6 16	1:10,560 Geol. M.S. 1:63,360 Geol. mapping 1:10,000 + 1:2500 topography	a.p. 1972 1976	detailed technical advice to preliminary design – pre public enquiry route alternatives given	sufficient for cutting and embankment slope, recommendations for bridge foundations	high quality for public enquiry	original detailed geological mapping
NW New Territories, Hong Kong Nov. '80 – Jan. '81	150	1:10,000 topographical 1:50,000 geological	a.p. 1979 1975 1965 1949 at 1:20,000	preliminary basic information for initial planning decisions	sufficient to establish relative cost implications of major planning options	internal working report 3 hand coloured drafts of maps	inter-disciplinary use of photo interpretation
Queensland Power St., Australia Dec. '80	four areas totalling 150 km ² 200–500 km apart	1:100,000 topographical 1:250,000 geological	1:30,000 to 1:80,000	preliminary basic cost information for site selection	sufficient to select one site for detailed design	rapid production for clients' internal use	rapid reconnaissance
Botswana Feeder Roads, Phase I – April–May '80 Phase II – Feb.– March '81	4000 1000	1:50,000 topographical	1:250,000 1:50,000	feasibility studies materials inventory	reports to inform potential aid donors	1:50,000 materials map of route. Good quality. No colour.	comparison of widely separated routes in vast unmapped area

Construction of embankments on soft clays

John Davies
Philip Dauncey

Introduction

Civil engineers have always been faced with the problem of constructing roads and in many instances these are required to cross soft boggy ground. This type of ground may exist in alluvial flood plains of rivers or in fenland and peat bogs. The engineer was perhaps not aware of the 'scientific' aspects that are now the tools of the geotechnical engineer, but he did know that his road should either avoid the soft ground or keep it on as low an embankment as possible. He knew intuitively if he started to have a slope stability problem he should load the toe until it stabilized, i.e. provide berms.

Currently there is increasing pressure, due to environmental reasons, for roads to be constructed across such difficult terrain and in many cases the economics of dealing with the problems are probably less than the cost of rerouting the road.

A recent survey has shown that in the last 10 years 40% of roads constructed in the United

Kingdom have involved significant sections across soft compressible soils.

When faced with construction of a road in these situations, the relative costs of providing a viaduct structure, compared with the embankment solution, must be considered. Nevertheless, on a current Arup job, where there are extremely difficult conditions for the construction of embankments, the costs for embankments are still only 50% of the viaduct solution.

Planning of the work

For the construction of an embankment on soft clays the planning for the investigation is similar to that for any investigation. The study is carried out in three stages:

- (1) Desk study
- (2) Site investigation works and preliminary design (including trial embankment if necessary)
- (3) Final design.

Desk study

The initial study includes the collection and assessment of existing geotechnical information on the area which includes:

- (1) Geology
- (2) Aerial photographs
- (3) Hydrology
- (4) Existing site investigation data.

Subsequently a field walkover of the route is carried out and the proposals for Phase 2, the site investigation, are made.

This paper concentrates on the latter two phases of the work, the site investigation, trial embankment, if necessary, and the methods of construction of the embankment.

The site investigation

Purpose

The purpose of the site investigation is to:

- (1) Define the geology along and across the alignment of the embankment
- (2) Determine values for the geotechnical parameters that are required for the design of the embankment.

The field work is normally done in two parts:

- (1) Boreholes to obtain samples and carry out in situ testing. These are limited in number because of relatively high cost.
- (2) In situ tests comprising Dutch Cone Soundings and in situ vane tests. These are relatively cheap and quick and a large number of tests can be carried out.

The Dutch Cone tests provide information between the borehole locations to enable the geology to be confirmed and any variations in strength across the site identified.

The boreholes are carefully carried out and fully supervised to ensure the maximum amount of information is obtained from the investigation. Full supervision also provides a flexibility of approach that is necessary in dealing with such soft soils with the resident engineer being able to change the approach in the light of the information obtained.

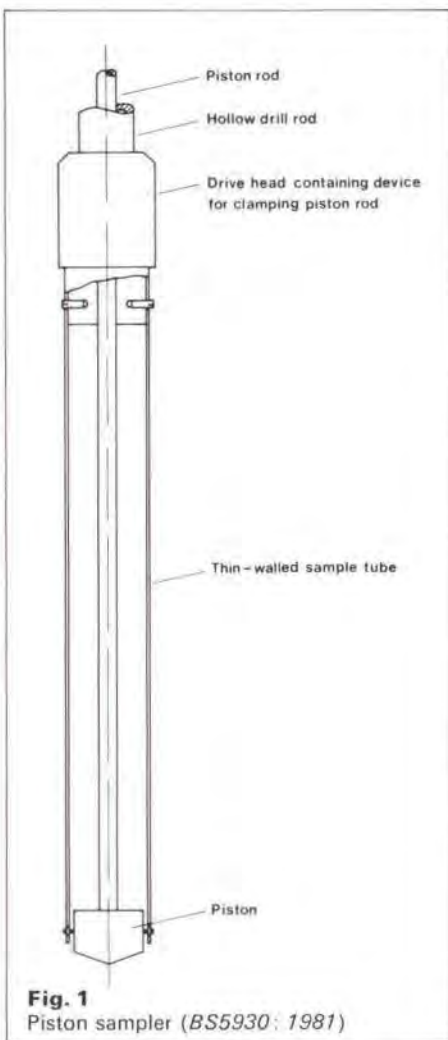

Fig. 1
Piston sampler (BS5930: 1981)

Borehole investigation

The boreholes are normally made using conventional shell and auger equipment¹ and undisturbed samples are obtained using a piston sampler (see Fig. 1). The samples are usually 100 mm diameter and 1,000 mm long although 54 mm diameter, 600 mm long samples are satisfactory for extruding on site for visual examination and index testing.

The normal procedure is to carry out sampling and testing in three adjacent holes (see Fig. 2). In the first hole, continuous piston samples are taken throughout the depth of the soft deposits. If the clays are extremely soft the piston sampler can be pushed to the level at which the sample is required without drilling a borehole. Alternatively, piston samples are taken approximately 2 m below the base of the borehole to ensure the ground has not been disturbed due to drilling. The maximum shear strength of a clay in which a piston sample can be obtained is about 40 kN/m².

These continuous samples are taken to a small laboratory on site, where they are extruded, split in half, and descriptions made of the soil and fabric. Photographs are taken and the samples allowed to dry. In drying, the structure of the clays may become more apparent. The laboratory should have facilities for extruding the samples, and carrying out moisture content and bulk density determinations.

As the samples are extruded, hand vane tests are made in the ends of the piston samples. Fig. 3 shows an extruded section of core from a piston sample with the locations where tests were carried out. Samples are then sent to the contractor's laboratories for other index tests such as gradings and Atterberg Limits.

A second borehole is then made adjacent to the first in which a profile of in situ vane tests are carried out². These are normally made

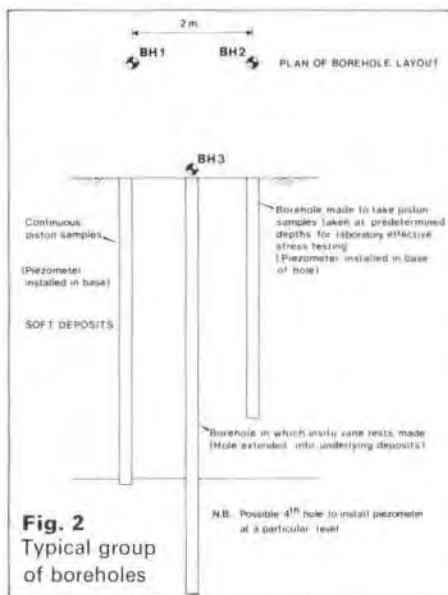

Fig. 2
Typical group of boreholes

at approximately 1 m intervals. The vane tests can either be made using a borehole vane or with a penetration vane. In soft clays the latter method is preferred since any disturbance in forming the borehole is avoided.

On the basis of the description of the split samples and the field vane strengths, depths at which undisturbed samples are required for detailed laboratory testing are selected. The third borehole in the group is then made to obtain these piston samples. Normally the third hole is not made until samples have been extruded, split, and described from a number of holes so that the typical material types have been identified and representative samples can be obtained.

These samples are then transported very carefully (in a vertical position) to the contractor's testing laboratory. Fig. 4 shows typical results obtained from a suite of three boreholes, i.e. shear strength, index properties and bulk densities. The results show how even with very basic testing useful information about the soils is immediately available. One of the three boreholes is normally extended below the soft clays into the underlying deposits using shell and auger techniques to provide standard geotechnical information. The drainage qualities of these underlying deposits is an important aspect to be investigated as this may affect the rate of consolidation of the soft clays. Casagrande type standpipe piezometers are installed in some or all of the boreholes and additional boreholes may be required to allow piezometers to be installed in the typical deposits. The piezometers are required both to monitor the piezometer pressures and allow in situ permeability tests to be carried out.

In situ permeability testing provides the most

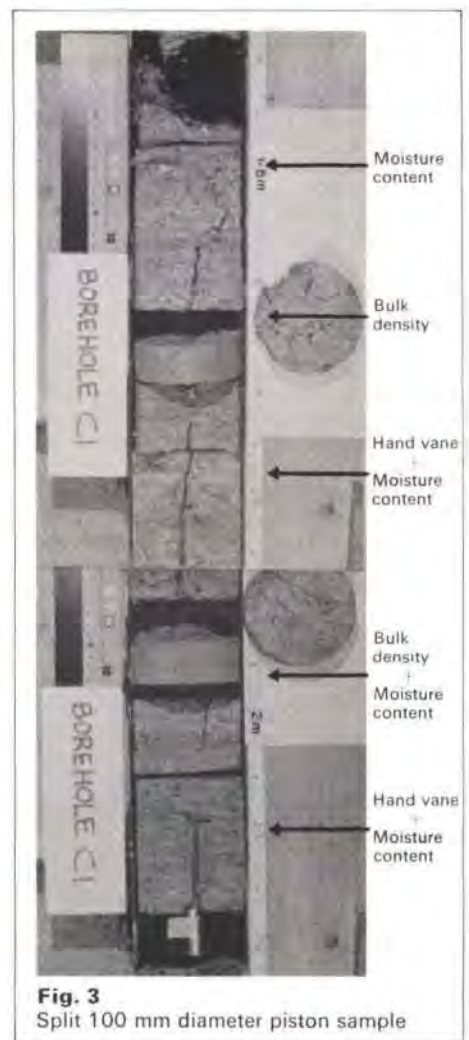
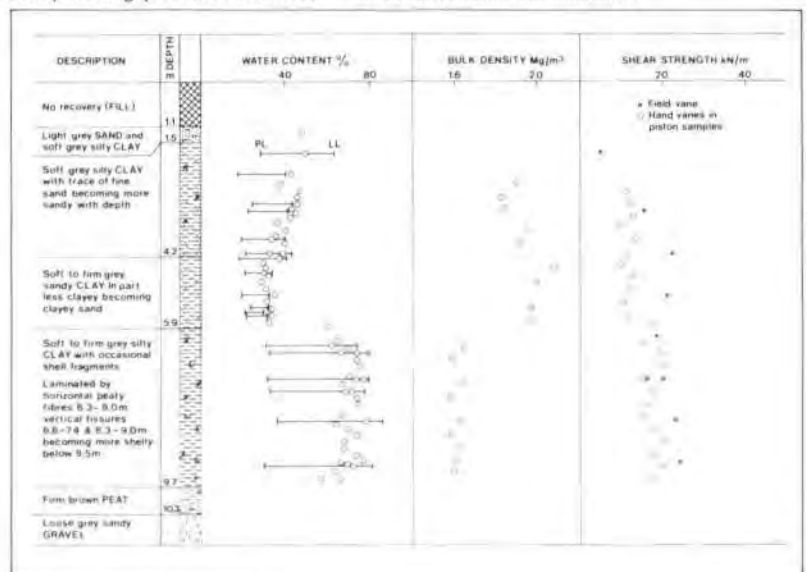

Fig. 3
Split 100 mm diameter piston sample

reliable method of estimating the field permeability and therefore the rate of consolidation of the soil under embankment loading. We have recently been using apparatus developed by Kent County Council Highways Laboratory³. The apparatus allows the piezometric level to be lowered, hence increasing the effective stress at the tip of the piezometer, and the permeability is assessed by measuring carefully the rate at which water has to be removed from the piezometer to maintain the depressed level. By increasing the amount by which the piezometric level is depressed, the effective stresses can be increased up to a limit of about 75 kN/m² above in situ stresses and the variation in permeability with effective stress determined. The results that have been obtained by this method have shown good correlation with field observations beneath embankments⁴.

Fig. 4
Borehole profile



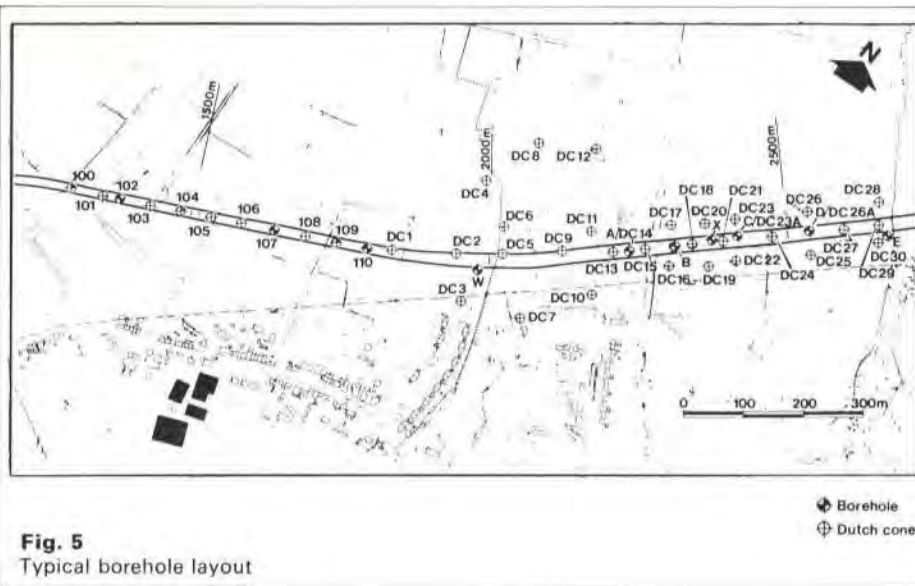

Table 1 Cone factor N_k

Soil type	Electric cone	Mechanical cone
Grey organic clay (Athlone)	12-17	14-18
Brown laminated clay (Athlone)	16-21	15-23
Organic silty clay (Galway)		10-15
Calcareous marl (Galway)		9-15
Inorganic silty clay (Galway)		10-40

Index testing

It is important to carry out the simple Atterberg Limit tests on the soft deposits and a number of correlations based on these test results have been derived to describe the behaviour of such deposits.

On the basis of the Liquid Limit, Plasticity Index, and moisture content and a knowledge of the vertical effective stress acting, an approximate estimate of strength and consolidation parameters may be obtained^{7, 8}.

Determination of shear strength

The following types of laboratory tests may be carried out to determine the shear strength:

- (1) Consolidated undrained triaxial compression tests
- (2) Consolidated undrained triaxial extension tests
- (3) Constant volume direct simple shear tests
- (4) Consolidated drained shear box tests.

All the tests give both the undrained shear strength parameter C_u , and effective strength parameters c' , ϕ' except (4) which only gives the effective strength parameters.

To obtain meaningful results from laboratory strength tests it is necessary to reconsolidate the samples to the existing in situ stresses or to higher stresses. This means that the samples need to be consolidated anisotropically where the ratio of the lateral consolidation stress (σ_H') to vertical consolidation stress σ_V' is K_0 (ie $\sigma_H' = K_0 \sigma_V'$).

By increasing the consolidation stresses above those existing in situ, the increase in strength under embankment loading can be measured.

In the triaxial cell (Tests (1) and (2)) the specimens tested are usually 38 mm diameter as the consolidation times for larger specimens are much longer. The specimens should be prepared using the Landva apparatus²⁹ to minimize disturbance. Side drains are usually necessary to reduce consolidation times but with very soft specimens the restraint provided by the drains may be a significant proportion of the measured strength. Once the sample has been consolidated it is sheared in undrained conditions with measurement of the pore water pressure. The test procedure is described in Reference 30.

Test (3), the direct simple shear test⁹, is a recently developed shear box test. With this apparatus the specimens are consolidated in K_0 conditions, i.e. no lateral strain and then sheared in undrained conditions. The advantages compared with the conventional shear box apparatus are that a uniform shear stress distribution is obtained, the failure surface is not controlled by the geometry of the apparatus and undrained conditions can be maintained at low rates of shear. The test apparatus for the direct simple shear test is shown in Fig. 9.

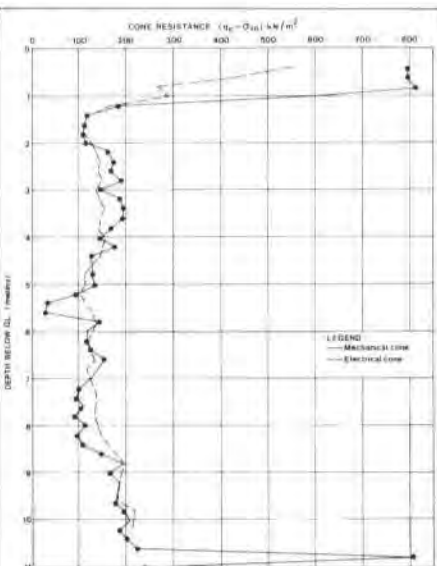

Fig. 6 Comparison of mechanical and electrical cone

Dutch Cone Soundings

Because of the time required, and relatively high cost of carrying out the detailed borings, these investigations are supplemented by a series of Dutch Cone Soundings.

These soundings provide data between boreholes and define the geology over larger areas. Fig. 5 shows a typical layout of cone soundings in relation to the detailed boreholes. A full description of the Dutch Cone is given in Sanglerat⁵. The procedure for the cone tests involves advancing a cone on the end of a rod into the ground at a controlled speed using hydraulic jacks and measuring the applied forces. Two parameters are measured:

- (1) The cone-bearing capacity at the tip (q_c).
- (2) Soil/steel friction (f_s) along a sleeve separate from and behind the cone.

The jacking forces are measured on pressure gauges in the mechanical cone. An electric cone has also been developed where the tip and sleeve resistances are measured using electrical strain gauges. Fig. 6 shows typical cone profiles using each method. The results from the penetrometer may be interpreted to obtain:

- (a) Assessment of soil type from the value q_c and the friction ratio f_s/q_c .
- (b) Assessment of the undrained shear strength of the clay.

Fig. 7 shows results obtained in the soft clays in Belfast where the two soil types are clearly distinguishable. However, in some situations the variations in soil type are difficult to distinguish. Fig. 8 shows one such situation in Athlone where two material types were identified from visual examination, but are not easily distinguished from the cone record.

The undrained shear strength of the clay C_u may be determined from the cone resistance q_c using the equation:

$$q_c = N_k C_u + \sigma_{v0}$$

where N_k is a cone factor and σ_{v0} is the total overburden pressure at the level of the cone. A simplified version of the equation ignoring the overburden pressure should not be used for soft clays since the overburden pressures may be of similar magnitude to $N_k C_u$.

The cone factor is dependent on the type of cone but, even for a particular type of cone, may vary considerably. It is necessary therefore to ensure that the cone is calibrated against in situ or laboratory strength data to obtain the particular value of N_k for each site. Typical results for N_k are shown in Table 1 where C_u has been obtained from field vane tests. Difficulties may arise in determining a value for N_k for very soft clays of low plasticity index⁶.

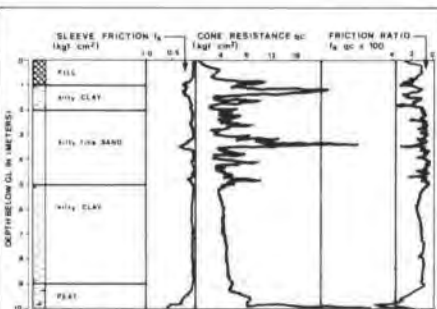

Fig. 7 Cone profile (Belfast)

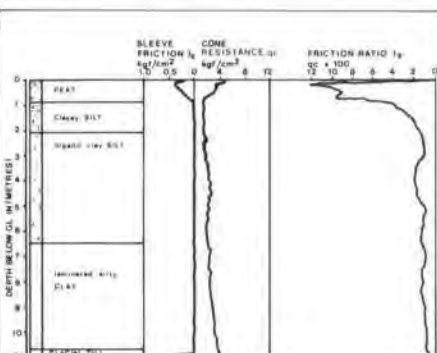

Fig. 8 Cone profile (Athlone)

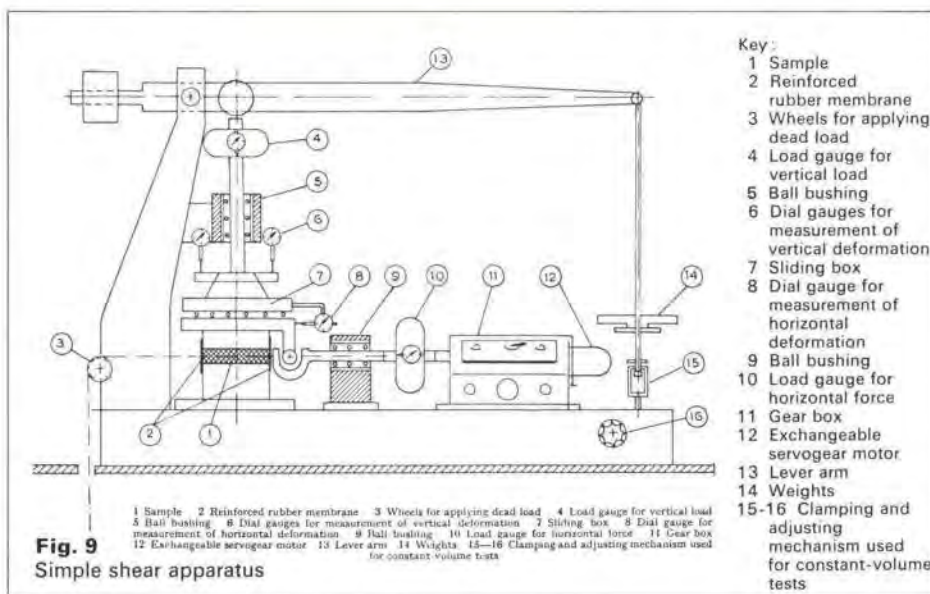
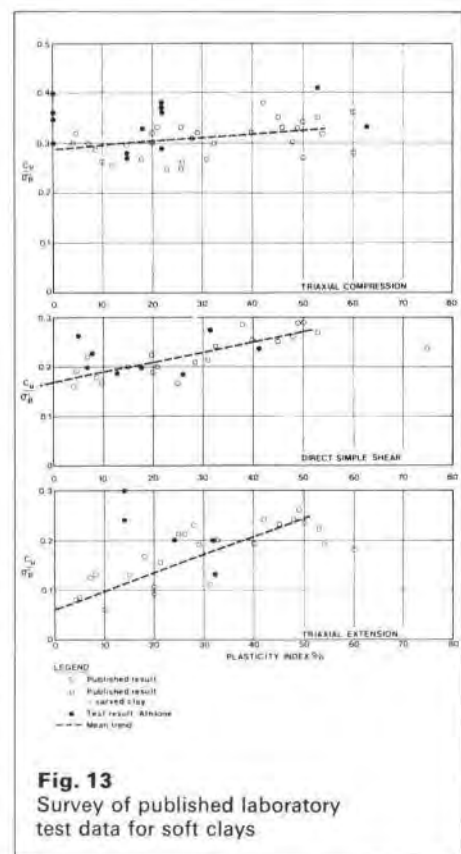
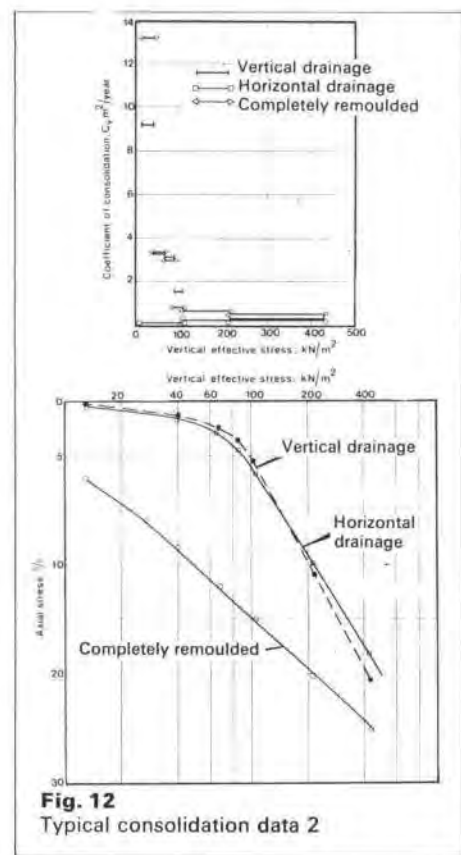
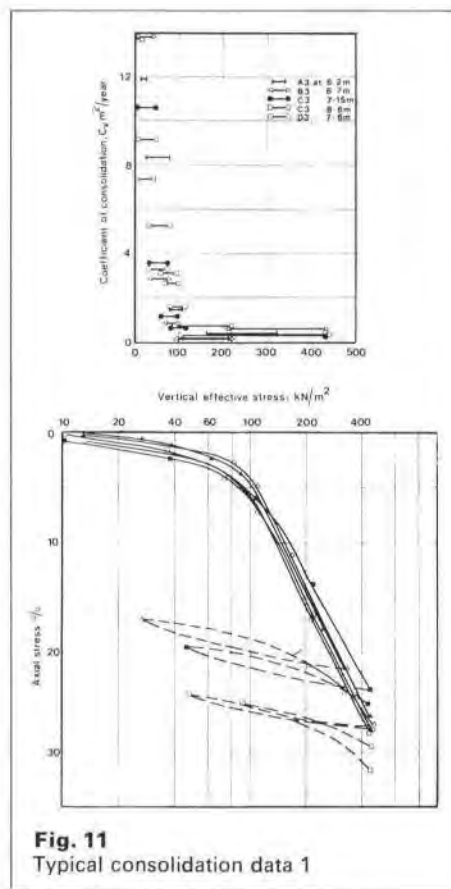
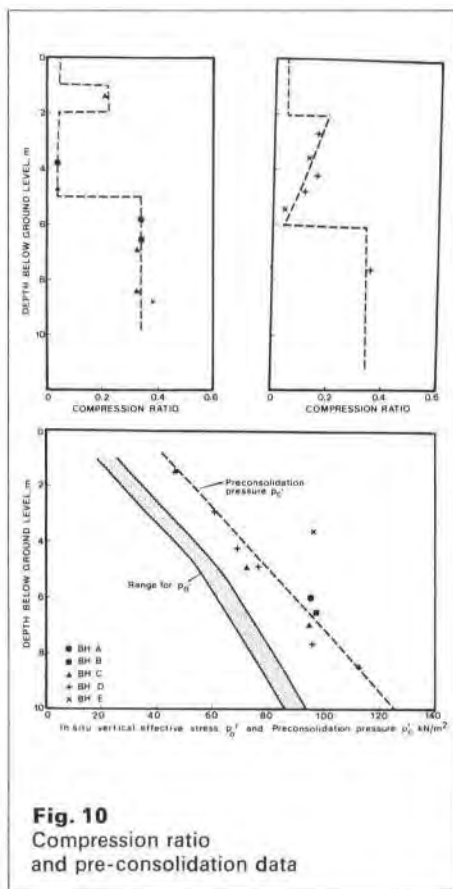

Fig. 9
Simple shear apparatus



Consolidation testing

Consolidation testing is normally carried out in the oedometer using specimens 75 mm diameter and 20 mm thick. The consolidation stages of the shear tests provide additional data and dissipation tests in a triaxial cell can also be used to obtain consolidation data. The specimen is taken from undisturbed piston samples and, to minimize disturbance during preparation, the sample is extruded directly into the oedometer ring and trimmed, using a fine wire, following the same principles used in the Landva apparatus. The load increments should be selected for each test so that the preconsolidation pressure can be determined, which is found using Casagrande's construction¹⁰. Typical results are shown in Fig. 10 for the preconsolidation pressure and for values of the compression ratio (defined as compression index C_c divided by $(1+e_0)$ where e_0 is the initial voids ratio). Typical consolidation data of axial strain and coefficient of consolidation against vertical effective stress is shown in Fig. 11.

It is interesting to note the results shown in Fig. 12 which are for samples tested from horizontal, vertical and remoulded samples from Belfast. The results for the coefficient of consolidation show very similar values which was thought to be due to the lack of preferential drainage paths within the deposit.

Geotechnical parameters for design

In the design of an embankment the four main criteria are:

- (1) Will the embankment be stable both during and after construction?
- (2) How much settlement will take place?
- (3) How long will it take to settle?
- (4) How long will it take to construct?

Although the criteria are all interlinked, the first criterion is based on shear strength parameters for the embankment and foundation clays, whilst the latter three depend mainly on the consolidation parameters for the clays.

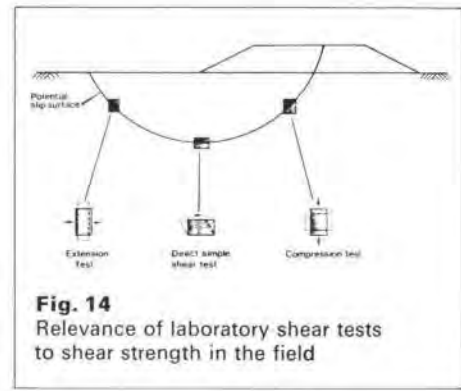

Strength

In nature many soils are found to exhibit normalized behaviour. For these soils, the undrained shear strength (C_u) may be normalized with respect to the maximum past consolidation pressure (σ'_p) and this normalized strength C_u/σ'_p is then independent of stress but a function of overconsolidation ratio and soil type. For a normally consolidated clay, the strength therefore is directly related to the effective overburden pressure. The normalized strength C_u/σ'_p forms the basis of the design of a stage loaded embankment, allowing the strength after varying degrees of consolidation to be estimated. It also provides a convenient basis for the comparison of various test results.

Fig. 13 shows a summary of published test data obtained from triaxial compression, extension and direct shear tests plotted as normalized shear strength against plasticity index. It can be seen that the C_u/σ'_p ratio increases with increasing plasticity of the clay and that the ratio of C_u/σ'_p varies with the type of test being carried out. In addition the field vane strengths may also be normalized with respect to existing vertical effective stress or preconsolidation pressures if these are known.

Fig. 14 shows the relevance of each type of laboratory test to the stability analysis. For stability analysis it is a combination of these strengths that will be relevant. From Fig. 13 it can be seen that the average of the results from the triaxial compression and extension tests is approximately equal to the results from the direct shear test. The mean of the test results is therefore normally used for design. If only results from compression tests are available, then it is usual to reduce the values obtained in line with the mean values of published data.

These values for design may be compared with the results obtained from vane tests which have been normalized with respect to the preconsolidation pressure obtained from oedometer tests. Fig. 15 shows typical results from a site at Queenborough.

It has been found however that when back analyses of embankment failures are made based on vane strength data the calculated factor of safety is sometimes in excess of unity and sometimes below. The difference in the values obtained is due both to the difference in the rate of strain to failure between a vane test and an embankment failure and to the stress induced anisotropy of the ground.

Bjerrum¹¹ has proposed an empirical correction factor derived from the back analyses that should be applied to the vane strengths to give a factor of safety of unity. This correction factor was found to vary with plasticity index and the relationship is shown in Fig. 15.

However, care must be taken in applying the correction especially where sensitive clays of low plasticity are involved¹², because of the scatter in the data on which they are based. Despite these difficulties, for the majority of clays with plasticity index in the range 20–60%, the correlation between vane and laboratory data is reasonable¹³, and may be used in design.

The major disadvantage with the vane shear strength test is that any strength anisotropy due to variation in the soil structure, for example resulting from the soil particles becoming orientated in a preferred direction during deposition or resulting from a laminated or varved structure, is not measured. This type of anisotropy is not related to plasticity index and cannot be taken account of using Bjerrum's correction. Different vane shapes such as various diamond shapes have

Fig. 15
Shear strength parameters

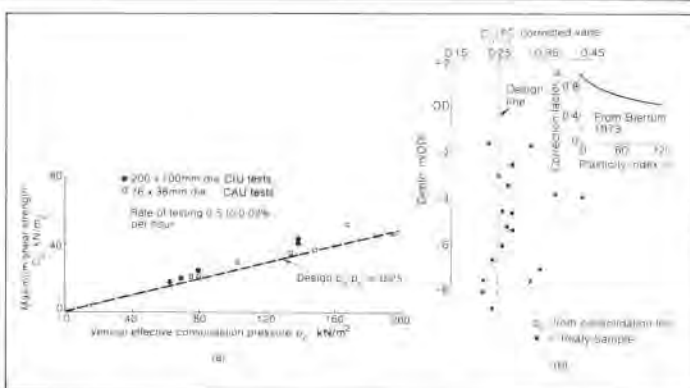
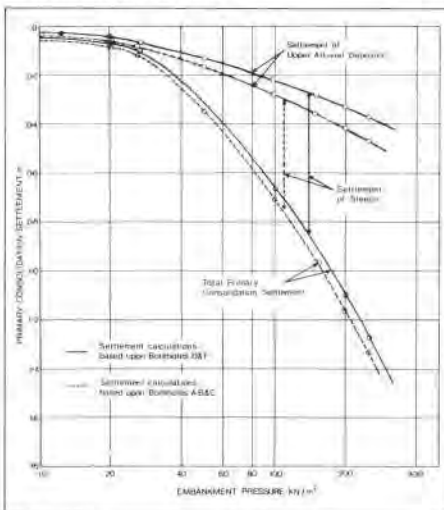

Fig. 16
Settlement predictions



been experimented with^{12,14} but there are a number of problems that arise in the interpretation of the results, e.g. the strains at the edges of a diamond vane are not uniform but increase with increasing distance from the axis of rotation.

Where a laminated or varved clay is concerned it may be that the strength measured in the direct shear test is not the mean of the triaxial extension and compression strengths but may lie below both. Hence in situations where structural anisotropy may play a part it is necessary to carry out the full range of tests to investigate the shear strength that may be mobilized.

Consolidation

Conventional oedometer tests carried out on carefully obtained piston samples provide a reasonable basis on which to calculate the magnitude of the settlement. Fig. 16 shows the typical results that have been obtained for a lightly overconsolidated clay at Belfast. Up to the preconsolidation pressure σ'_p the settlement will be relatively small but increase rapidly as the loading exceeds σ'_p .

The primary settlement is calculated using the expression:

$$\rho = \sum d \left\{ \frac{C_s}{1+e_0} \log \left(\frac{\sigma'_p}{\sigma'_{vo}} \right) + \frac{C_c}{1+e_0} \log \left(\frac{\sigma'_{vo} + \Delta\sigma'_v}{\sigma'_p} \right) \right\}$$

where ρ is the primary settlement
 d is the thickness of layer under consideration
 C_s is the recompression index
 $1+e_0$ is the compression index
 C_c is the compression index
 $1+e_0$ is the compression index
 σ'_p is the apparent preconsolidation pressure

σ'_{vo} is the *in situ* vertical effective stress

$\Delta\sigma'_v$ is the applied load.

Once primary consolidation is complete then the embankment will continue to settle or creep as a result of secondary consolidation.

The amount of secondary consolidation is calculated using the expression:

$$\rho_s = \sum d C \alpha \log (t_1 + \Delta t) / t_1$$

where ρ_s is the secondary consolidation settlement

$C \alpha$ is the rate of secondary consolidation

t_1 is the time for primary consolidation

Δt is the time following the end of primary consolidation

To calculate the rate of primary consolidation of the soft deposits the following equation is used:

$$T = t \frac{C_H}{H^2} \text{ and } C_H = \frac{k}{\gamma_w m_v}$$

where k is the field permeability

m_v is the coefficient of compressibility as measured in the laboratory oedometer over the stress range changes in the field

γ_w is the unit weight of water

H is the length of the drainage path

T is the Terzaghi time factor (related to degree of consolidation)

t is the time after the application of the load causing consolidation

C_H is the coefficient of consolidation for horizontal drainage.

Fig. 17 shows a typical relationship between the coefficient of consolidation (C_v or C_H)

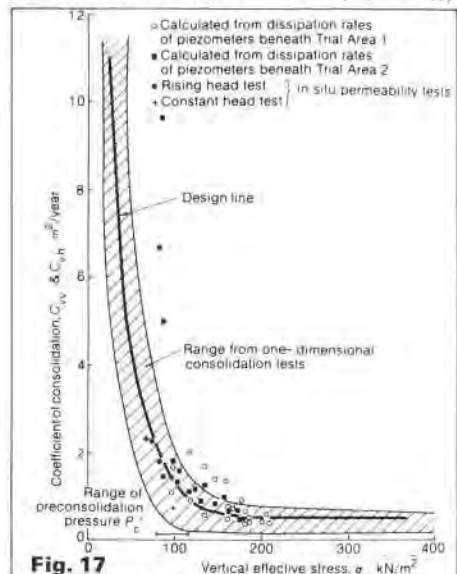

Fig. 17
Variation of coefficient of consolidation with vertical effective stress

and vertical effective stress σ'_v . It can be seen that there is a rapid reduction in the measured value of the coefficient of consolidation as the loading approaches the preconsolidation pressure and thereafter remains approximately constant.

Fig. 17 also shows that good agreement can be obtained between the laboratory oedometer tests, field permeability tests and back analysis of a trial embankment. This is not always the case and the reason for the good agreement of this data was the homogeneous nature of the soft clay, examination of the split samples having indicated that there were few or no preferential drainage paths. This example illustrates the importance of visual observation of the structure of the clays.

The marked variation in the coefficient of consolidation with stress is an important factor in determining the time for consolidation to occur. Changes in C_H of at least an order of magnitude may be expected under embankment loading, resulting in similar changes in the time for primary consolidation. Arups have developed a computer program¹⁵ to deal with this problem.

Stability analysis

The normal method of analysis used is the limit equilibrium method in which the slope stability is considered by calculating the peak shear force that can be mobilized on a potential slip surface. The factor of safety is defined as the ratio of the resisting moment due to the shear forces acting along the surface to the overturning moment of the slipped mass.

The analysis can be carried out either in terms of total stresses or effective stresses. The more rigorous method is in terms of effective stresses but this requires the estimation of more parameters than a total stress analysis (c' , ϕ' , total stress and pore pressure compared with C_u only). It is the estimate of pore pressure at failure which provides the most difficult problem. As shear stresses are introduced into an element of clay, pore pressures are generated, and for normally or lightly overconsolidated clays these are positive. The pore pressures generated depend on the overconsolidation ratio, stress level and sensitivity and are difficult to predict in field situations¹⁷. In addition, other shortcomings in the limit equilibrium method significantly affect analyses in terms of effective stress¹⁸.

For these reasons, total stress analyses based on undrained shear strength can be used with much greater confidence than effective stress analyses. The basis of the total stress method is that the critical stage in the stability of an embankment is its short-term undrained behaviour since, with increasing time, consolidation will occur, resulting in an increase in strength and an increase in the factor of safety against failure.

Using the relationship between undrained shear strength and effective overburden pressure, the strength is predicted, assuming various degrees of consolidation, and the stability of the embankment is analyzed.

The minimum factor of safety usually used in the analysis is 1.25 and normally Bishop's simplified method of slope analysis is used¹⁹ using circular arcs. Non-circular analysis may be carried out using Janbu's method²⁰ if the laboratory testing or geological conditions suggest this is a possible mode of failure.

In the initial calculations the geometry of the embankment is determined to give the minimum specified factor of safety immediately following the addition of the final lift of filling. The most economical profile of embankment normally requires that about 90% of consolidation (and therefore gain in strength) has occurred prior to the placing of the final lift.

At lower embankment heights it is probable that lesser degrees of consolidation give the specified minimum factor of safety. Stability charts showing the allowable excess pore pressures prior to placing each lift of fill may be produced to control the rate of placement of fill on the embankment.

Fig. 18 shows a section with berms, that has been analyzed for stability.

Construction methods

If preliminary analyses indicate that there are problems with the stability and/or settlement performance of the embankment, the following options may be considered:

- Accept the in situ properties of the soil and transfer the loading to a more stable level.
- Attempt to improve the properties of the soil by treatment, e.g. (1) use of vertical drains to shorten the drainage paths (2) lime columns, where lime is mixed with the clay to increase the shear strength and reduce compressibility.
- Replace the soft deposits by more competent materials such as sand or gravel.

No treatment

To ensure the stability without treatment of the ground the following methods may be considered:

- Vary the geometry of the embankment, e.g. by adding stabilizing berms.
- Construct the embankment in stages using the gain in shear strength resulting from consolidation of the soil.
- Use a lightweight fill in the construction of the embankment, e.g. use PFA.
- Transfer the embankment load by means of piles to a lower, more competent stratum.

The following methods may be used to reduce the magnitude of settlements:

- Use lightweight fill to reduce loads.
- Use a temporary surcharge.

Improve the properties of the soil

There are a number of methods that have been employed to improve the soil properties:

- Introduce vertical drains which reduce the drainage path and therefore accelerate the rate of consolidation and rate at which there is a gain in shear strength.
- Use lime columns where unslaked lime is introduced via an augered hole to mix with the clay, changing the chemical composition of the clay and increasing the shear strength. The compressibility of the clay is also reduced.
- Use of electro-osmosis to increase the shear strength.
- Vacuum preloading to reduce the pore pressures below atmospheric pressure by means of a pumping system. This is really a form of surcharging and causes consolidation without introducing stability problems.
- Dynamic compaction whereby a large weight is dropped onto the ground surface. This again is a form of surcharging.

Replacement techniques

Two alternative methods may be adopted in the replacement method:

- Excavation of the soft deposits and replacement by a sand, gravel or rock fill. This is usually used where the thickness of soft deposits does not exceed 5 to 6 m.
- Displacement of the soft clays. This is generally more economic if the depth of the clays exceeds 6 m. The weight of the embankment used then must exceed the bearing capacity of the ground.

In general a combination of the techniques described have been adopted for the jobs Arups have undertaken. In some instances stability of the embankment has not been a problem and only the rate of settlement needed to be considered⁴. In other situations both stability and settlement are critical and a combination of variation of geometry, stage loading and vertical drains and surcharging have been used. Elsewhere, where the soft deposits are less than 6 m deep, replacement has been proposed. A recent example of this flexibility is shown in Reference 12.

By far the most common form of ground improvement used in difficult conditions is the vertical drain and a brief description of the technique is given below. The other methods such as lime columns are not discussed because of their limited application²¹.

A number of reviews on drains are available^{21, 22, 23}.

Vertical drain design

Vertical drains are used to accelerate primary consolidation by reducing the drainage path for the dissipation of excess pore water pressures.

They were first proposed in 1926 to improve the drainage characteristics of soft clays and

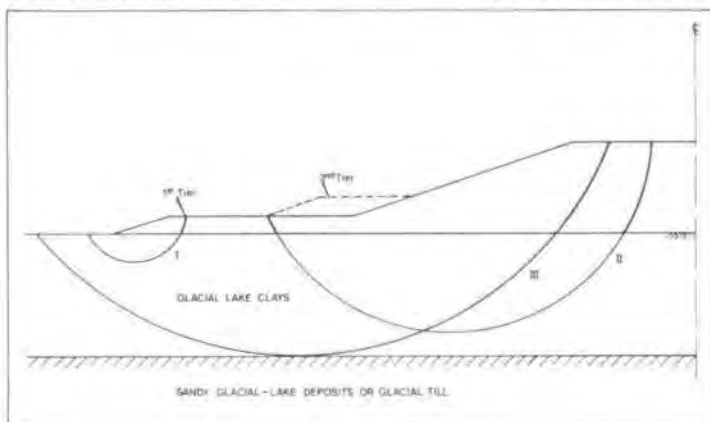

Fig. 18 Possible modes of failure of embankments with berms

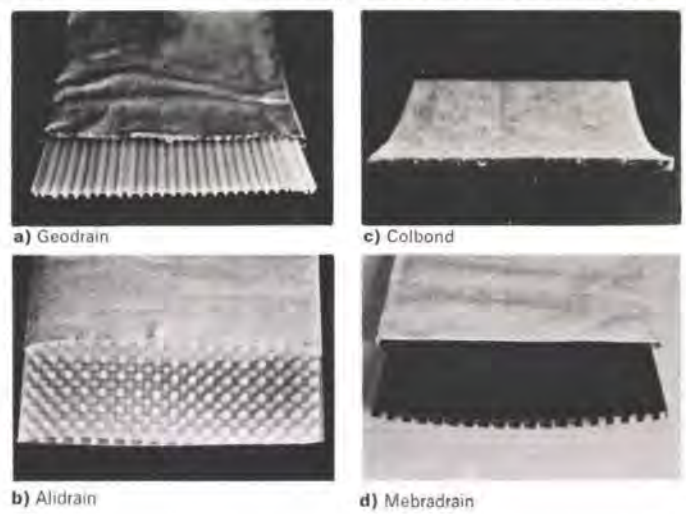

Fig. 19 a) to d) Band drains

sand drains were first used in California in 1936. In about 1936 Kjellman²⁴ developed the cardboard drain.

A large number of vertical drainage systems are now available including both sand drains and prefabricated wick type drains. A review of the types and methods of installation is given by Hansbo²⁵. The three basic types are:

(1) Traditional sand drains, generally 160 mm to 750 mm diameter, installed by augering and replacement

(2) The Sandwich Drain²⁶ made of 65 mm diameter porous fabric stockings filled with medium sand, installed using a wash boring or displacement technique.

(3) Prefabricated band drains generally consisting of a plastic core and a synthetic fibre or paper filter (see Fig. 19) installed very rapidly using a jetting or probing technique. Normally these are 100 mm wide and 3-7 mm thick.

Arups have had experience using all of these types of drains and Table 2 shows a summary of the jobs:

The method of determining the dimensions and spacing of drains is normally based on the theory of radial consolidation developed by Barron²⁷, but variations of this equation have been developed²⁸. It can be shown that both horizontal and vertical drainage can be combined as follows:

$$(1-U) = (1-U_r)(1-U_v)$$

where U_r is the degree of consolidation for radial flow, U_v the degree of consolidation for vertical flow and U is the resulting overall degree of consolidation²⁸.

The basic equation for radial flow is

$$U = 1 - e^{-\frac{C_H t}{B}}$$

where B is a constant given by

$$B = \frac{S^2}{8} \left(\frac{nS-3}{d} - \frac{1}{4} \right)$$

and S is the spacing and d the diameter of the drain.

Many attempts have been made to take into account change of permeability (or $\frac{C_v}{C_H}$) and Arups have developed a computer program which allows the variation in C_v with increasing vertical effective stress to be used in calculating the dissipation of excess pore pressures.

Since all the methods of analysis are based on circular drains it is necessary to convert the band drain to an equivalent circular drain diameter. In the analysis the design spacing required for the drains is quite sensitive to the diameter used. Back analysis of case histories has shown that the use of 100 mm wide 3-7 mm thick band drains is equivalent to a 50 mm diameter sand drain.

However, if the values of drain diameter and coefficient of consolidation are chosen to give agreement with the trial data, then these would be satisfactory to use in the drain design. It is not necessary to know the absolute values of each parameter. Large equivalent diameters have been suggested but it is likely that the value of the coefficient of consolidation used has not been appropriate to the field condition.

By the use of a trial embankment the measured rate of dissipation of pore pressures can be analyzed as a function of the drain diameter and C_H acting. Unless two drain spacings are adopted and the results compared, it is not possible to relate dissipation to drain diameter or C_H separately.

A relationship between C_v and drain diameter is shown in Fig. 20. For a specified degree of consolidation, doubling the effective drain diameter from 50 mm to 100 mm is equivalent to a change of the coefficient of

Table 2: Summary of jobs using different drain types

Site	Drain Type
Belfast	Conventional 200 mm diameter sand drains
Belfast	Prefabricated drain consisting of plastic core and polypropylene filter (<i>Alidrain</i>)
Belfast	Prefabricated drain with paper filter (<i>Mebra drain</i>)
Sandwich	Sandwich drains (Cementation Sandwich)
Queenborough (England)	Sandwich drains (Cementation Sandwich) A V Colbond drains which consisted of a non-woven polyester 300 mm wide fabric strip which acts both as drain and filter.
Washington (England)	Plastic core with filter (<i>Mebra band drain</i>)
Athlone (Ireland)	Plastic core with fabric filter (Summer 1982)

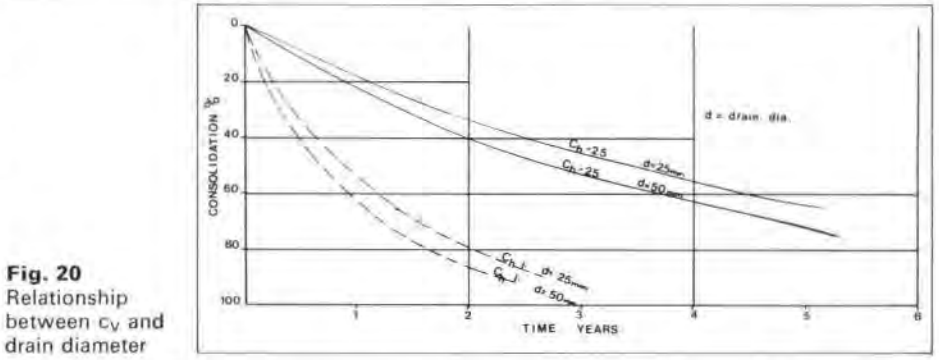

Fig. 20
Relationship between C_v and drain diameter

consolidation of 20% and a 20% error in time. However if the coefficient of consolidation is incorrectly estimated by 100% the degree of consolidation will be grossly miscalculated and the time error will also be near 100% for full dissipation.

Trial embankment

Following the site investigation and preliminary design, the need for a trial embankment can be assessed.

The cost of installation of vertical drains is such that, where the length of the road is significant, the savings in drain numbers that may be achieved by widening the drain spacing made possible as a result of more accurate consolidation parameters being obtained from the trial would probably cover the cost of the trial embankment.

Where the embankment is a significant part of the cost of a project and some ground improvement methods are required or the time scale is critical, a trial embankment may be crucial for an economic design.

The aspects of the design that may be investigated in a trial embankment include:

- (1) The rate of consolidation of the soft deposits
- (2) The stability of the embankment during construction
- (3) The magnitude of primary and possibly secondary consolidation settlements
- (4) Lateral and vertical movements outside the toe of the embankment which may affect adjacent structures
- (5) The efficiency of any vertical drain installation in accelerating consolidation
- (6) Construction methods for raising the embankments.

The embankment shape should be such that end effects are minimized. However, there is a balance in size between a trial which is representative but at the same time economical. Generally an embankment with a length three times the width fulfils this criterion. For embankments raised over 4 m the width at the crest should be about 15 m.

Instrumentation

Instrumentation will be required for the monitoring of the performance of a trial

embankment and will usually be necessary to control the rate of filling of the embankments.

The instruments normally used by Arups are as follows:

- (1) Piezometers to measure pore water pressures
- (2) Settlement gauges to measure vertical movements
- (3) Inclinometers to measure horizontal movements.

Future developments are likely to lead to the use of pressure cells to measure the increase in stresses directly in the ground.

The most important aspects that must be considered when selecting instruments are:

- (1) Response time and accuracy
- (2) Durability and reliability under field conditions.

It is also important to cost the work necessary in collecting and analyzing the data obtained and in this respect automation of the readout systems is likely to be used more frequently. An on-site micro computer may also be used to reduce, store and plot data and it is proposed to use an on site computer on a current job.

Piezometers

The piezometers measure the pore water pressure beneath the embankments. The main types used are:

- (1) Standpipe piezometers
- (2) Hydraulic piezometers
- (3) Pneumatic piezometers

Electrical piezometers are available but they are expensive and therefore rarely used. Automation of the readout is possible for all types of piezometer.

Standpipe piezometers

Standpipe piezometers are simple to use and the cheapest form available, but are particularly prone to damage on site and do not have a rapid enough response time to measure rapid increases in piezometric pressures in clays.

Arups usually install a number of these instruments in the more permeable deposits and also as a long-term check on other types of piezometers.

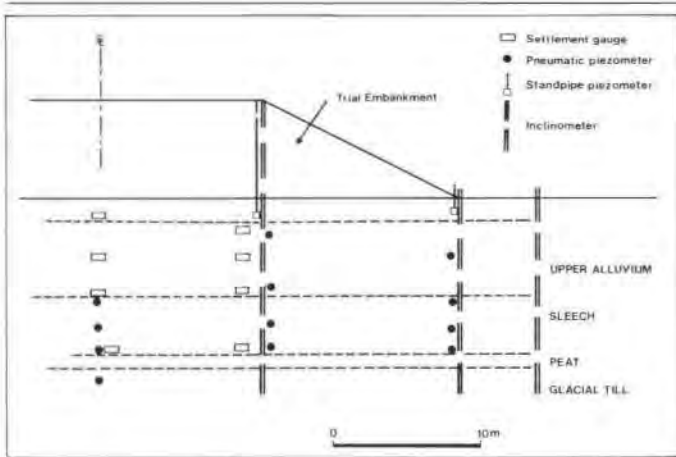

Fig. 21
Instrumentation layout

Table 3: Site investigation data

Site	Plasticity Index	TE	Cu		Reference
			DSS	TC	
Ellingsrud	4	0.08	0.16	0.30	Larsson (1980)
Olav Kyrres Plass	4.5	0.08	0.19	0.32	Larsson (1980)
Mastemyr	7	0.125	0.22	0.30	Larsson (1980)
Manglerud	9	0.13	0.18	0.29	Larsson (1980)
Drammen Lean	10	0.06	0.17	0.26	Larsson (1980)
Belfast	12	—	—	0.255	Arup files
Portsmouth, USA	15	0.13*	0.20	0.295*	Ladd <i>et al</i> (1977)
Haney	18	0.17	—	0.27	Ladd <i>et al</i> (1977)
Vaterland	20	0.105	0.225	0.30	Larsson (1980)
Studerterlund	20	0.09	0.19	0.32	Larsson (1980)
Boston Blue Clay	21	0.155	0.20	0.33	Ladd and Foott (1974)
Galway Inorganic Clay	23	—	—	0.245	Arup files
Weald Clay	26	—	—	0.26	Ladd <i>et al</i> (1977)
Favren	26	0.21	—	0.33	Larsson (1980)
Sundland	28	0.23	—	0.31	Larsson (1980)
Mucking	29	0.19	—	0.32	Wesley (1975)
Drammen Plastic	31	0.11	0.215	0.27	Larsson (1980)
Maine	38	—	0.285	—	Ladd <i>et al</i> (1977)
AGS	40	0.195	0.255	0.32	Ladd <i>et al</i> (1977)
St. Herblain	42	0.24	—	0.38	Josseume <i>et al</i> (1977)
San Francisco Bay Mudd	45	0.23*	0.25	0.35	Ladd <i>et al</i> (1977)
Belfast	46	—	—	0.33	Arup files
Ska Edeby	48	0.24	0.26	0.30	Jardine (1980)
Kalleback	49	0.26	0.29	0.33	Larsson (1980)
Backebol	50	0.235	0.29	0.34	Larsson (1980)
Sandwich	50	—	—	0.27	Arup files
Lilla Mellosa	53	0.22	0.27	0.35	Larsson (1980)
Cubzac	54	0.19	—	0.32	Josseume <i>et al</i> (1977)
Lanester	60	0.18	—	0.36	Jasseume <i>et al</i> (1977)
Queenborough	60	—	—	0.28	Arup files
Atchafalaya	75	—	0.24	—	Ladd <i>et al</i> (1977)
Connecticut Valley Varved	39/12	0.21	0.165	0.25	Ladd <i>et al</i> (1977)
Po Delta Varved	40/25	0.20	0.24	0.30	Jardine (1980)
New Liskeard Varved	47/10	—	0.21	—	Lacasse and Ladd (1977)
Matagami Varved	47	0.40	0.41	0.70	Bjerrum (1973)
Baastad	15	0.08	0.18	0.33	Gregersen and Løken (1979)
Kings Lynn	39	0.23	0.55	0.37	Simons and Menzies (1978)
Bangkok	41	—	0.27	—	Bjerrum (1973)

Note⁵:
TE Triaxial Extension Test
DSS Direct Simple Shear Test

TC Triaxial Compression Test
* Plane strain test

Hydraulic piezometers

Hydraulic piezometers are less prone to damage since the hydraulic leads may be buried in trenches. However, they do require a centralized instrument house for gauges or manometers. The instruments are susceptible to freezing and need to be de-aired at regular intervals.

Pneumatic piezometers

Pneumatic piezometers contain a diaphragm with the water pressure on one side and on the reverse two pneumatic lines from a gauge point. Pressure is applied to one lead until the water pressure is balanced, at which point the diaphragm opens allowing a return flow of air. Pressure is measured in the return lead.

The pneumatic lines are buried in trenches as protection against damage.

The readout unit is relatively complicated and expensive. However the instrument is very easy and rapid to operate and becomes economical if many instruments are installed. One disadvantage is that the datum reading cannot be re-established and an allowance has to be made for the settlement that the piezometer will undergo. In addition the piezometer cannot be de-aired and its long-term performance over many years has not been proved.

These instruments have been used successfully on a number of projects but careful preparation and installation is required.

Settlement gauges

The main types of gauges employed are:

- (1) Surface settlement plates
- (2) Plate and probe systems
- (3) Remote single gauges (Pneumatic settlement gauges).

Surface settlement plates

These have the obvious advantage of cheapness and direct reading but are liable to damage by construction plant.

Plate and probe systems

These consist of magnetic or steel settlement rings installed around a central access tube. A magnetic or electric sensor which operates when adjacent to the settlement rings is lowered down the access tube and hence the level of each ring may be established.

The main disadvantage with this type of instrument is that an access tube is required to be brought up through the embankment during construction and is therefore prone to damage by construction plant.

Remote single gauges

These are similar to the pneumatic piezometers except that a head of mercury instead of water is measured. By knowing the level of the gauge readout point and measuring the pressure, the level of the settlement gauge may be calculated. Disadvantages are the high pressures that need to be measured and their accuracy is suspect at depths greater than 6 to 7 m below the gauge house level. Their main advantage is that no access tubing is required to be brought up through the embankment and the ease and simplicity of reading which may be automated.

Lateral movement gauges

Two alternative methods are used to measure lateral movements:

- (1) Alignment stakes
- (2) Inclinator.

Alignment stakes

These are surface stakes installed just outside the toe of the embankment and offsets are measured using a theodolite. An obvious advantage is cheapness but they do require that the reference points at either end be on stable ground. As with surface settlement points they are vulnerable to damage.

Inclinator

An inclinometer consists of access tubing with grooves spaced at 90° around the circumference which are usually orientated such that one axis is at right angles to the line of the embankment.

A torpedo with wheels which lock into the grooves in the access tubing is lowered down the tubing and the verticality of the probe is measured at equal intervals down the tube. It is assumed the toe of the tube is in a rigid stable stratum, and the measurements taken are integrated along the inclinometer to measure the lateral movements.

Fig. 21 shows a typical layout of instrumentation adopted for a trial embankment whilst Fig. 22 shows results obtained from piezometers below a trial embankment.

Conclusions

On the basis of the site investigation, laboratory testing and trial embankment the final design of the main embankments may be carried out. However, it is important to review continually the construction and response of instruments to ensure that the assumptions made and deduced from the investigations remain valid.

Finally, it is important that, because of the complexity of the problems, every opportunity is taken to write up the case histories. It is only in this way that the geotechnical engineer can learn from other people's successes, and also failures.

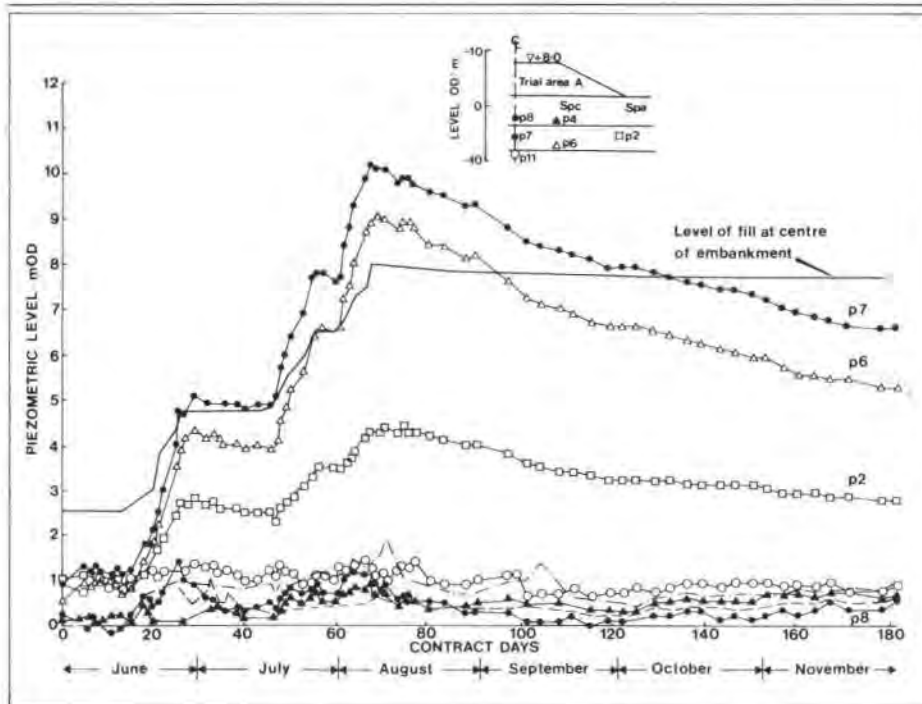

Fig. 22
Variation of piezometric level
with time for trial embankment

References

- (1) COLE, K. W. State of the art review of soil sampling in the United Kingdom. Asian Conf. Mech. & Found. Eng. Singapore, 1979.
- (2) BRITISH STANDARDS INSTITUTION. *BS 5930*: Code of practice for site investigations. BSI, 1981.
- (3) NICHOLSON, D. P. and JARDINE, R. J. Performance of vertical drains at Queenborough by-pass. *Geotechnique* 31 (1), pp. 67-90, 1981.
- (4) DAVIES, J. A. and HUMPHESON, C. A comparison between the performance of two types of vertical drains beneath a trial embankment in Belfast. *Geotechnique*, 31 (1), pp. 19-31, 1981.
- (5) SANGLERAT, G. The penetrometer and soil exploration. Interpretation of penetration diagrams - theory and practice. Elsevier, 1972.
- (6) O'RIORDAN, N. J., DAVIES, J. A. and DAUNCEY, P. C. The interpretation of static cone penetrometer tests in soft clays of low plasticity. European Symposium on Penetration Testing, Amsterdam, May 1982.
- (7) UNITED STATES DEPARTMENT OF THE NAVY. NAVAL FACILITIES ENGINEERING COMMAND. Design manual: soil mechanics foundations, and earth structures. The Department, 1971.
- (8) LAMBE, T. W. and WHITMAN, R. V. Soil mechanics. Wiley, 1969.
- (9) BJERRUM, L. and LANDVA, A. Direct simple shear tests on a Norwegian quick clay. *Geotechnique*, 16 (1), pp. 1-32, 1966.
- (10) CASAGRANDE, A. The determination of the pre-consolidation load and its practical significance. Proceedings of the First International Conference on Soil Mechanics and Foundation Engineering, 3, section D34, pp. 60-64, Cambridge, Mass., 1936.
- (11) BJERRUM, L. Problems of soil mechanics and construction on soft clays and structurally unstable soils (collapsible, expansive and others). Proceedings of the Eighth International Conference on Soil Mechanics and Foundation Engineering, 3, session 4, pp. 111-153, 1973.
- (12) OVE ARUP & PARTNERS. Athlone relief road. Arup internal report, 1981.
- (13) OVE ARUP & PARTNERS. M2, M1 extension, Belfast. Arup internal report, 1981.
- (14) SIMONS, N. E. and MENZIES, B. K. Stability of embankments on soft ground. Developments in soil mechanics. Applied Science Publishers, 1978.
- (15) COLE, K. W. Discussion: session 7, consolidation. Computer applications to geotechnical problems in highway engineering. Proceedings of symposium held in Cambridge, 1-2 April 1980. Sponsored by the Department of Transport.
- (16) DUNCAN, J. M., Finite element analyses of stresses and movements in dams, excavations and slopes, state-of-art, applications of the finite element method of geotechnical engineering. Proceedings of the symposium held by the U.S. Army Engineer Waterways Experiment Station, 1-4 May, 1972 at Vicksburg, Miss. pp. 267-326, Sept. 1972.
- (17) LEROUEIL, S. et al. Construction pore pressures in clay foundations under embankments. Part I: The Saint Alban test fills. *Canadian Geotechnical Journal*, 15 (1), pp. 54-68, 1978.
- (18) TAVANAS, F. and LEROUEIL, S. The behaviour of embankments on clay foundations. *Canadian Geotechnical Journal*, 17 (2), pp. 236-260, 1980.
- (19) BISHOP, A. W. The use of pore pressure coefficients in practice. *Geotechnique*, 4 (4), pp. 148-152, 1954.
- (20) JANBU, N. Application of composite slip surface for stability analysis. Proceedings of the European Conference on Stability of Earth Slopes, 1954.
- (21) PILOT, G. Methods of improving the engineering properties of soft clay, International Symposium on Soft Clay, Bangkok, p. 61, 1977.
- (22) BJERRUM, L. Embankments on soft ground - general report. Proceedings of the ASCE Conference on Performance of Earth and Earth Supported Structures, 2, pp. 1-54, Purdue University, 1972.
- (23) BROMS, B. B. Discussion on problems of soil mechanics and construction on soft clays and structurally unstable soils. Proceedings of the Eighth International Conference on Soil Mechanics and Foundation Engineering, 4 (2), pp. 120-122, Moscow, 1973.
- (24) KJELLMAN, W. Consolidation of fine grained soils by drain wells. *American Society of Civil Engineers Transactions*, 113, pp. 718-742, 1948.
- (25) HANSBO, S. Consolidation of clay by band shaped prefabricated drains. *Ground Engineering*, 12 (5), pp. 21-25, 1979.
- (26) Sandwicks at Sandwich. *Ground Engineering*, 11 (6), pp. 53-55, 1979.
- (27) BARRON, R. A. Consolidation of fine-grained soils by drain wells, *American Society of Civil Engineers Proceedings*, 73 (6), pp. 811-835, 1947.
- (28) TERZAGHI, K. Theoretical soil mechanics. John Wiley, 1943.
- (29) LANDVA, A. Equipment for cutting and mounting undisturbed specimens of clay in testing devices. Norwegian Geotechnical Institution Publication no. 56. Oslo, 1964.
- (30) BISHOP, A. W. and HENKEL, D. J. The measurement of soil properties in the triaxial test. Arnold, 1957.

